



GTP-870HD Preamp/Processor

User's Manual



- *The latest version of the firmware is required to enable all functionality described in this manual.*
- *Check the Adcom website (www.adcom.com) for firmware updates.*

Congratulations





Congratulations on your purchase of the Adcom GTP-870HD

You have made a wise choice that will reward you with exceptionally accurate musical sound reproduction for years to come. To realize the full potential of your new preamp/processor, please read these operating and installation instructions thoroughly before attempting to make any connections to it.

The GTP-870HD is not only designed to reproduce the highest quality sound and picture but also to deliver the greatest possible value. It is our engineers' passion for perfection that has enabled our components to be judged the equivalent of others costing two, three, or even five times as much. Our engineering team consistently strives to develop and design products that will exceed your expectations. Our goal at Adcom is to let more consumers hear high-end quality sound and see high-end video without paying high-end prices.

All Adcom components are the result of a long-standing dedication to innovation, quality, simplicity, and value. Adcom: We have the power — and now, so do you!

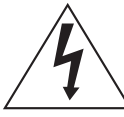
Thank you from the Adcom Team

	CAUTION RISK OF ELECTRIC SHOCK DO NOT OPEN	
	This symbol is intended to alert the user to the presence of uninsulated dangerous voltage within the product's enclosure that may be of sufficient magnitude to constitute risk of fire or electric shock.	
	This symbol is intended to alert the user to the presence of important operating and maintenance instructions in the literature accompanying this product.	
	Do not place this unit on an unstable cart, stand, tripod, bracket, or table. The unit may fall, causing serious injury to a child or adult, and serious damage to the unit. Use only with a cart, stand, tripod, bracket, or table recommended by the manufacturer or sold with the unit. Any mounting of the device should follow the manufacturer's instructions, and should use a mounting accessory recommended by the manufacturer.	
PORTABLE CART WARNING (Symbol provided by RETAC)		

Copyrights/Trademarks

Published by Adcom
Copyright © 2006 Adcom, LLC
All rights reserved

Adcom and the Adcom logo are registered trademarks of Adcom, LLC.

This unit is manufactured under license from Dolby Laboratories Licensing Corporation. It is additionally licensed under one or more of the following patents: U.S. number 3,959,880, Canadian numbers 1,004,603 and 1,037,877.

Dolby® Pro Logic®, Dolby ProLogic II®, Dolby Digital EX®, and Dolby Digital® are registered trademarks of Dolby Laboratories Licensing Corporation.

Manufactured under license from Digital Theater Systems, Inc. US Patent Number 5,451,942 and other world-wide patents issued and pending. "DTS®," "dts®," "DTS Digital Surround®," "DTS-ES®," "DTS NEO:6®" are trademarks of Digital Theater Systems, Inc. Copyright 2003 Digital Theater Systems, Inc. All rights reserved.

HDMI, the HDMI logo and High-Definition Multimedia Interface are trademarks or registered trademarks of HDMI Licensing LLC.

No part of this manual may be reproduced or electronically transmitted without the express written consent of Adcom, LLC.

Chapter 1 - Welcome

Introduction	5
Key Features.....	5
Unpacking the GTP-870HD	5
Placing the GTP-870HD	6
About the Remote Control	6
Front Panel Overview	7
Remote Control Overview	8
Rear Panel Overview	10
Display Overview	12

Chapter 2 - Connections

Connections Overview	13
Before You Begin	13
AM/FM Antenna Connections	14
Basic Audio/Video Connections	15
DVD Player Connections	16
Component/Progressive Scan Connections ...	17
Digital Audio Connections	18
HDMI Connections	19
External Decoder Connections	20
CD/Tape Player Connections	21
TV/Monitor Connections.....	22
Speaker Placement	23
Amplifier Connections (XLR)	24
Amplifier/Subwoofer Connections (RCA) ...	25
Video Recorder Connections	26
Tape Out/Aux Connections	27
Room 2 Connections	28
Control Connections	29
Power Connections	30

Chapter 3 - Setup

Setup Overview	31
Setup Navigation	32
Input Configuration.....	33
HD Scaler Configuration	34
Picture Controls.....	35
Volume/Tone Configuration	36
Speaker Configuration	37
Delay Configuration	38
Channel Balance	39
Pro Logic IIx/Neo:6 Configuration	40
Room 2 Basic Configuration	41
Room 2 Advanced Configuration	42
System Configuration.....	43
Input Labeling.....	44
Analog Input Level	45
Remote Control Setup	46
Using Preprogrammed Commands	47
Programming Remote Commands	50
Deleting Remote Commands	51
Programming Macro Buttons	52
Discrete Remote Control Commands	53

Chapter 4 - Operations

Operations Overview.....	55
Basic Audio/Video Playback.....	56
Picture Format	56
External 7.1 Playback	56
Tape Playback.....	56
Selecting Surround Modes	57
Tone Control.....	58
Basic Recording	59
Tuner Operations	60
System Operations	61
Room 2 Operations	62

Chapter 5 - Help

Customer Support	63
Adcom Protection Plan	63
Product Care & Maintenance	63
System Reset	63
Troubleshooting.....	64
Technical Specifications	65
Index	66

Important Safety Instructions

- Read all the safety and operating instructions before connecting or using this unit.
- Retain this notice and the owner's manual for future reference.
- All warnings on the unit and in its operating instructions should be adhered to.
- All operating and use instructions should be followed.
- Do not use this unit near water. For example, near a bathtub, washbowl, kitchen sink, laundry tub, in a wet basement, or near a swimming pool.
- The unit should be installed so that its location or position does not interfere with its proper ventilation. For example, it should not be situated on a bed, sofa, rug, or similar surface that may block the ventilation openings; or placed in a built-in installation, such as bookcase or cabinet, that may impede the flow of air through its ventilation openings.
- The unit should be situated away from heat sources such as radiators, heat registers, stoves, or other devices (including amplifiers) that produce heat.
- The unit should be connected to a power supply outlet only of the voltage and frequency marked on its rear panel.
- This Class I apparatus shall be connected to a MAINS socket outlet with a protective earthing connection.
- As the plug is used as the disconnect device, the disconnect device shall remain readily operable.
- The power supply cord should be routed so that it is not likely to be walked on or pinched, especially near the plug, convenience receptacles, or where the cord exits from the unit.
- Clean unit only as recommended in its instruction manual.
- The power supply cord of the unit should be unplugged from the wall outlet when it is to be unused for a long period of time and during electrical storms.
- Care should be taken so that objects do not fall, and liquids are not spilled, into the enclosure through any openings.
- This unit should be serviced by qualified service personnel when:
 - a. The power cord or the plug has been damaged; or
 - b. Objects have fallen, or liquid has been spilled, into the unit; or
 - c. The unit has been exposed to rain, or liquids of any kind; or
 - d. The unit does not appear to operate normally, or exhibits a marked change in performance; or
 - e. The device has been dropped, or the enclosure damaged.

Regulatory Information

FCC Part 15 This product has been tested and found to comply with the limits for a Class B digital device, pursuant to Part 15 of the FCC Rules. These limits are designed to provide reasonable protection against harmful interference when the product is operated in a residential installation. This product generates, uses, and can radiate radio frequency energy and, if not installed and used in accordance with the instruction manual, may cause harmful interference to radio communications. However, there is no guarantee that interference will not occur in a particular installation. If this product does cause harmful interference to radio or television reception, which can be determined by turning the product off and on, the user is encouraged to try to correct the interference by one or more of the following measures:

- Reorient or relocate the receiving antenna.
- Increase the separation between the product and receiver.
- Connect the product into an outlet on a circuit different from that to which the receiver is connected.
- Consult the dealer or an experienced radio/TV technician for help.

WARNING

TO REDUCE THE RISK OF FIRE OR ELECTRIC SHOCK, DO NOT EXPOSE THIS UNIT TO RAIN OR MOISTURE.

CAUTION

TO PREVENT ELECTRIC SHOCK DO NOT USE THIS POLARIZED PLUG WITH AN EXTENSION CORD, RECEPTACLE OR OTHER OUTLET UNLESS THE BLADES CAN BE FULLY INSERTED TO PREVENT BLADE EXPOSURE.

THERE ARE NO USER SERVICEABLE PARTS IN THIS PRODUCT. DO NOT ATTEMPT SERVICING OF THIS UNIT YOURSELF. REFER SERVICING TO QUALIFIED SERVICE PERSONNEL.

CAUTION POWER LINES

Any outdoor antenna must be located away from all power lines.

OUTDOOR ANTENNA GROUNDING

If an outside antenna is connected to your tuner or tuner/pre-amplifier, be sure the antenna system is grounded so as to provide some protection against voltage surges and built-up static charges. Section 810 of the National Electrical Code, ANSI/NFPA No. 701984, provides information with respect to proper grounding of the mast and supporting structure, grounding of the lead-in wire to an antenna discharge unit, size of grounding conductors, location of antenna discharge unit, connection to grounding electrodes, and requirements for the grounding electrode.

- a. Use No.10 AWG (5.3 mm²) copper, No.8 AWG (8.4 mm²) aluminum, No.17 AWG (1.0 mm²) copper clad steel or bronze wire, or larger, as a ground wire.
- b. Secure antenna lead-in and ground wires to house with standoff insulators spaced from 46 feet (1.221.83 m) apart.
- c. Mount antenna discharge unit as close as possible to where lead-in enters house.
- d. Use jumper wire not smaller than No.6 AWG (13.3 mm²) copper, or the equivalent, when a separate antenna grounding electrode is used. See NEC Section 810-21 (j).

EXAMPLE OF ANTENNA GROUNDING AS PER NATIONAL ELECTRICAL CODE INSTRUCTIONS CONTAINED IN ARTICLE 810. RADIO AND TELEVISION EQUIPMENT.

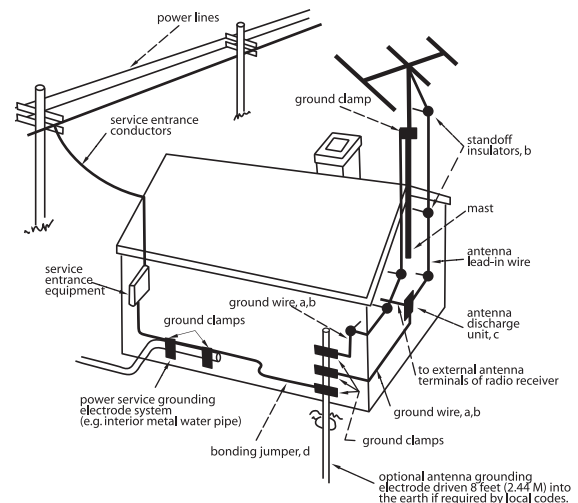

NOTE TO CATV SYSTEM INSTALLER

This reminder is provided to call the CATV system installer's attention to Article 82022 of the National Electrical Code that provides guidelines for proper grounding and, in particular, specifies that the cable ground shall be connected to the grounding system of the building, as close to the point of cable entry as practical.

Chapter 1 - Welcome

Introduction

Introducing Adcom's new take on the Preamp/Processor: the no-nonsense GTP-870HD.

Who hasn't grown weary of manufacturers claiming every product on offer as redefining some elusive "standards" or idealizing the ever popular catch-all, "state of the art?" Well, so have we.

So instead of assaulting you with yet another slew of marketing buzzwords and hyperbolic claims, we'll just proudly introduce to you Adcom's latest no-nonsense product: The GTP-870HD Preamp/Processor.

Intended to satisfy your requirements for a convenient, uncomplicated home entertainment solution, here's a single-chassis package of Adcom separates-performance pedigree, with plenty of power and the stability into low impedance loads to drive any loudspeaker encountered.

Offering a comprehensive list of useful features and digital signal processing modes, the GTP-870HD forgoes costly cosmetic flourishes in exchange for a long-lasting high level of overall build quality, with changeable internal circuit-card construction and functioning serial port communication for future updates and upgrades.

No hype, no nonsense. Just superior performance and lasting value for your money. What you've come to expect from Adcom.

Key Features

- HDMI™ video switcher routes all HDMI and upconverted legacy sources (composite, S-video, and component video) through a single HDMI cable
- Built in Video DSP converts standard NTSC 480i and PAL 576i signals to the output resolution of your display device (up to 1080p)
- Dolby Digital EX, DTS ES and Pro Logic IIx
- Upgradable: Hardware and software-addressable for accommodation of future advancements
- Low voltage protection minimizes effects of power line dips
- Flexible bass management & system calibration
- Independent Room 2 Out with advanced equalization

Unpacking the GTP-870HD

Before you begin, please take a moment to make sure the following items were included with your GTP-870HD:

- GTP-870HD
- Remote control
- 1.5V AAA batteries (4)
- Audio/video cable
- FM antenna
- FM antenna adapter
- AM loop antenna
- Power cord
- Warranty card & statement
- Quick Reference Guide
- User's guide CD



Placing the GTP-870HD

Place the GTP-870HD on a stable, vibration-free surface away from moisture and out of direct sunlight. Your Adcom dealer will be pleased to show you many different types of audio/video equipment racks and cabinets.

The GTP-870HD's rear panel is the central connecting point for almost every component in your audio/video system. Be sure to leave sufficient room behind the rear panel to accommodate cables, antenna leads, power cords, etc. We recommend a minimum of 5 inches of free space for maximum flexibility.

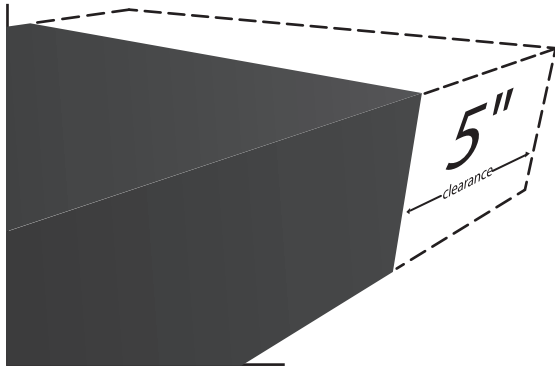

A distance of 1/2" should be maintained around the GTP-870HD for ventilation. Keep your GTP-870HD in a room where temperatures remain fairly moderate, and never cover it with table cloths, curtains, newspapers, etc., to avoid potential overheating.

About the Remote Control

The GTP-870HD comes with a universal, programmable, backlit, ergonomic remote control that is ready for action in every sense of the word.

- For an overview of each remote button, see page 8.
- To program the remote, see page 46.

Inserting the Remote Batteries

- 1 Remove the cover on the back panel of the remote control.
- 2 Insert four AAA alkaline batteries, paying attention to the correct polarities.
- 3 Replace the cover.

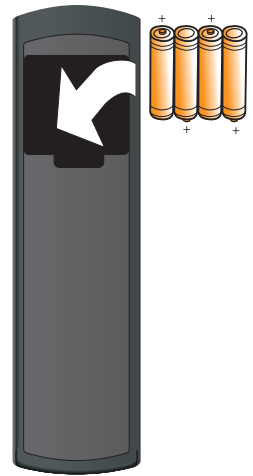

Front Panel Overview

The following is an overview of the GTP-870HD front panel.

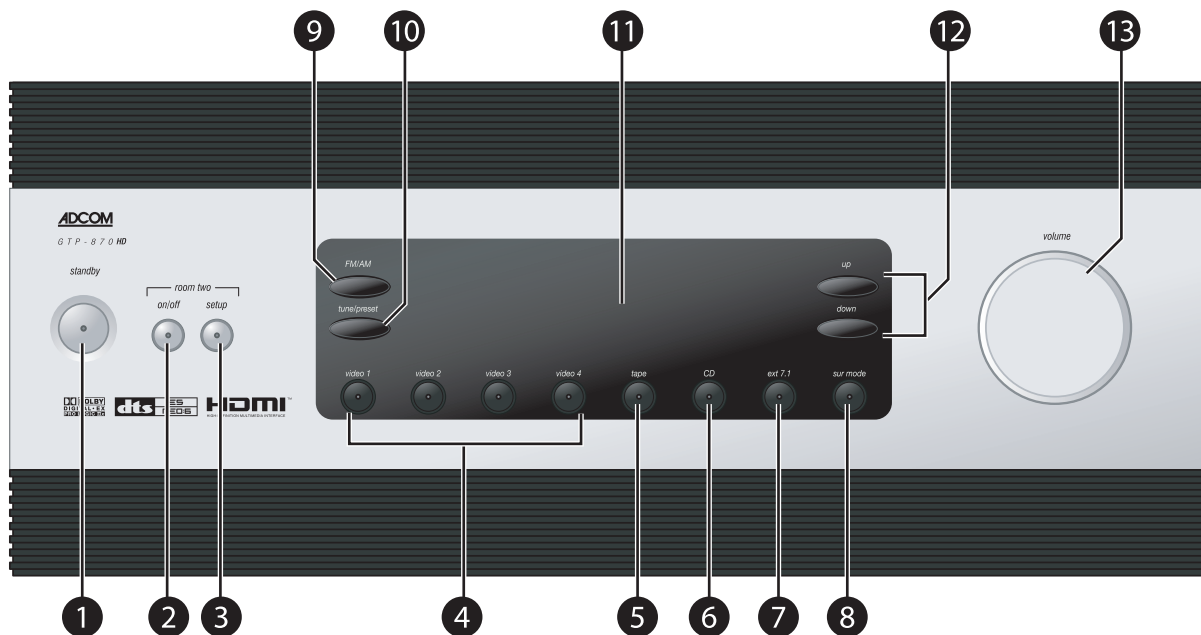

- 1 Standby button**

Powers the GTP-870HD on/off (Standby mode).

 - The rear panel power switch must be on (1) for this button to function.
 - The Power LED glows amber in Standby mode and red in On mode.
- 2 Room Two On/Off button**

Activates the GTP-870HD's Zone 2 outputs, usually connected to an amplifier/receiver in a second room.
- 3 Room Two Setup button**

Displays the Zone 2 configuration menu.

 - Press repeatedly to step through the Room 2 menu options and use the Volume knob to make selections.
- 4 Video 1-4 buttons**

Selects the Video 1-4 inputs.

 - Selecting an input activates its audio, video, and configuration settings.
- 5 Tape button**

Monitors the Tape output, usually connected to a recording device (e.g., a VCR or tape deck).
- 6 CD button**

Selects the CD input, usually connected to a CD player.
- 7 Ext 7.1 button**

Selects the Ext 7.1 inputs, usually connected to a DVD, DVD-Audio, or SACD player.
- 8 Surr Mode button**

Steps through all available surround modes (e.g., Dolby Digital, DTS, etc.) for the selected input.

 - Your selection will override the default surround mode for the input.
- 9 FM/AM button**

Selects Tuner mode. Press repeatedly to switch between the FM and AM tuner bands.
- 10 Tune/Preset button**

In Tuner mode, switches between manual and preset tuning.
- 11 Front panel display**

Displays GTP-870HD menus and status information (see page 12).
- 12 Up/Down buttons**

In Tuner mode, selects stored presets or manually scans the selected tuner band.
- 13 Volume knob**

Adjusts the volume level for the selected input.

Remote Control Overview

The following is an overview of the GTP-870HD remote control buttons and their operations.

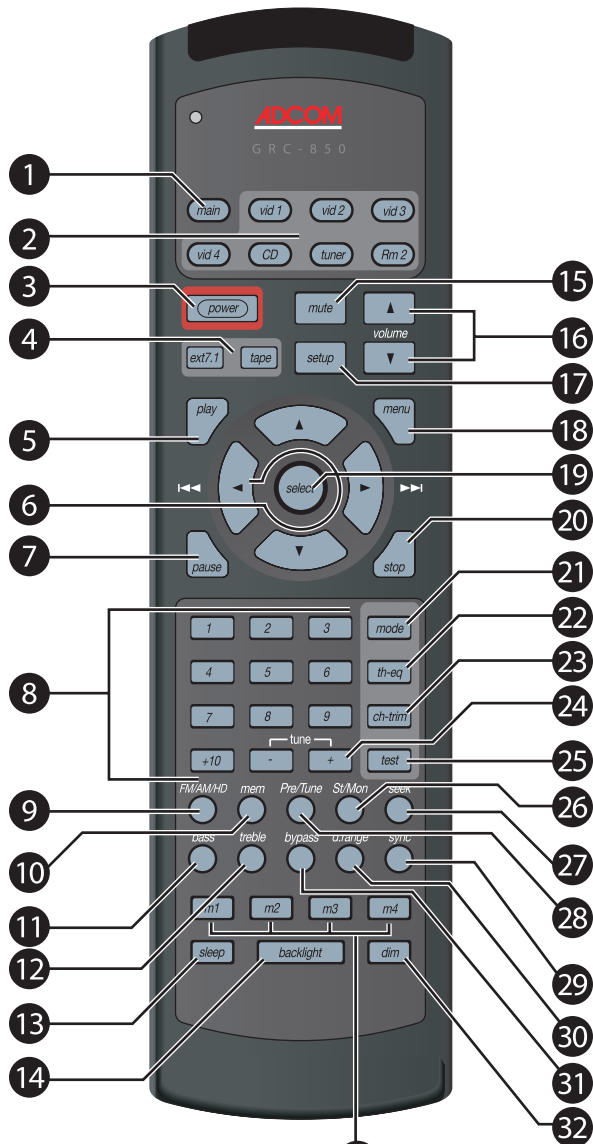

Note: The GTP-870HD has **33** programmable remote buttons that can be “taught” to control virtually any component in your home theater system. To program the remote for each input source, see page 46.

1 Main button

Selects the GTP-870HD itself, and sets the remote control to the command set associated with the main unit (see page 47).

- In Main mode, pressing any button on the remote control will cause the Main button to glow indicating that the GTP-870HD is active.

2 Source Selector buttons

- Vid 1-4** - Selects the Video 1, Video 2, Video 3, or Video 4 input, including the video, audio, and configuration settings associated with that input. Also sets the remote control to the command set associated with that input (see page 47).
- CD** - Selects the CD input, including all configuration settings associated with that input. Also sets the remote control to the CD command set (see page 48).
- Tuner** - Selects the Tuner input, including all configuration settings associated with that input. Also sets the remote control to the Tuner command set (see page 49).
- Rm 2** - Selects the zone 2 outputs, including all configuration settings associated with that output. Also sets the remote control to the Room 2 command set (see page 49).

3 Power button

Powers the GTP-870HD on and off (Standby).

- The rear panel power switch must be on (1) for this button to function.

4 Input Select buttons

- Ext7.1** - Selects the Ext 7.1 inputs, usually connected to a DVD, DVD-Audio, or SACD player.
- Tape** - Monitors the Tape output, usually connected to a recording device (e.g., a VCR or tape deck).

5 Play button

Programmable button. Can be taught to start playback of the selected source component.

6 Arrow buttons

Use to navigate the front panel display and on-screen menus.

7 Pause button

Programmable button. Can be taught to pause playback of the selected source component.

8 0-9, 10+ buttons

Programmable buttons. Can be taught to make direct selections (e.g., of DVD chapters or CD tracks) for the selected source component.

9 FM/AM/HD button

In Tuner mode, switches between the FM and AM tuner bands.

10 Mem button

In Tuner mode, stores the selected station as a preset.

- 11 Bass button**
When Tone Control is on (by pressing the Bypass button), displays a Bass adjustment display. Use ◀/▶ to set the desired Bass level.
- 12 Treble button**
When Tone Control is on (by pressing the Bypass button), displays a Treble adjustment display. Use ◀/▶ to set the desired Treble level.
- 13 Sleep button**
Sets the sleep timer to power the GTP-870HD off after a specified length of time (30-180 minutes).
- 14 Backlight button**
Turns the remote control backlight on.
• The backlight times out after ~8 seconds.
- 15 Mute button**
Mutes the audio for the selected input.
- 16 Volume ▲/▼ buttons**
Adjust the volume level for the selected input from -80 dB to +18 dB.
- 17 Setup button**
Displays the GTP-870HD Setup menu on the front panel and on-screen displays.
- 18 Menu button**
Programmable button. In Main mode, displays the Setup menu. Can be taught to display the Disc Menu on your DVD player.
- 19 Select button**
Displays the Picture Format menu. Use ◀/▶ to select a preset format (Auto, Full, Zoom, Squeeze, or Non Linear Stretch) to suit your display device and source material.
• Also use the Select button to make selections in setup menus and on-screen displays.
- 20 Stop button**
Programmable button. Can be taught to stop playback of the selected source component.
- 21 Mode button**
Steps through all available surround modes (e.g., Dolby Digital, DTS, etc.) for the selected input.
• The Mode button overrides the preset surround mode for the selected input.
- 22 TH-EQ button**
Turns Theater EQ sound on and off.
- 23 Ch-Trim button**
Displays the Channel Balance menu, which allows you to make custom adjustments to individual speaker levels during playback. A test tone option is provided.
- 24 Tune +/- buttons**
In Tuner mode, manually scans the selected tuner band, or selects stored presets.
- 25 Test button**
Plays a test tone for a few seconds in each speaker to aid in setting channel balance.
- 26 St/Mon button**
In Tuner mode, switches between Stereo and Mono reception.
• Choosing Mono may improve reception of a poor quality FM station.
- 27 Seek button**
In Tuner mode, scans the selected band and automatically tunes in stations with strong signals.
- 28 Preset/Tune button**
In Tuner mode, switches between manual and preset tuning.
- 29 Sync button**
Displays the Lip Sync Delay menu. If the picture and soundtrack are out of sync, use ◀/▶ to delay the audio signal from 0-169mS.
• While the Lip Sync Delay menu is displayed, press the Sync button again to toggle lip sync delay on and off.
- 30 Dynamic Range button**
Adjusts the dynamic range; i.e., the difference between the loudest and quietest passages in an audio soundtrack.
• The default setting is 100% (maximum range).
- 31 Bypass button**
Toggles Tone Control on and off. When Tone Control is on, use the Bass and Treble buttons to manually adjust the tone.
- 32 Dim button**
Steps through three brightness level for the front panel display.
- 33 Macro buttons (1-4)**
Programmable buttons. Can be taught to store and execute up to ten button presses; see page 52.

Rear Panel Overview

The following is an overview of the GTP-870HD rear panel.

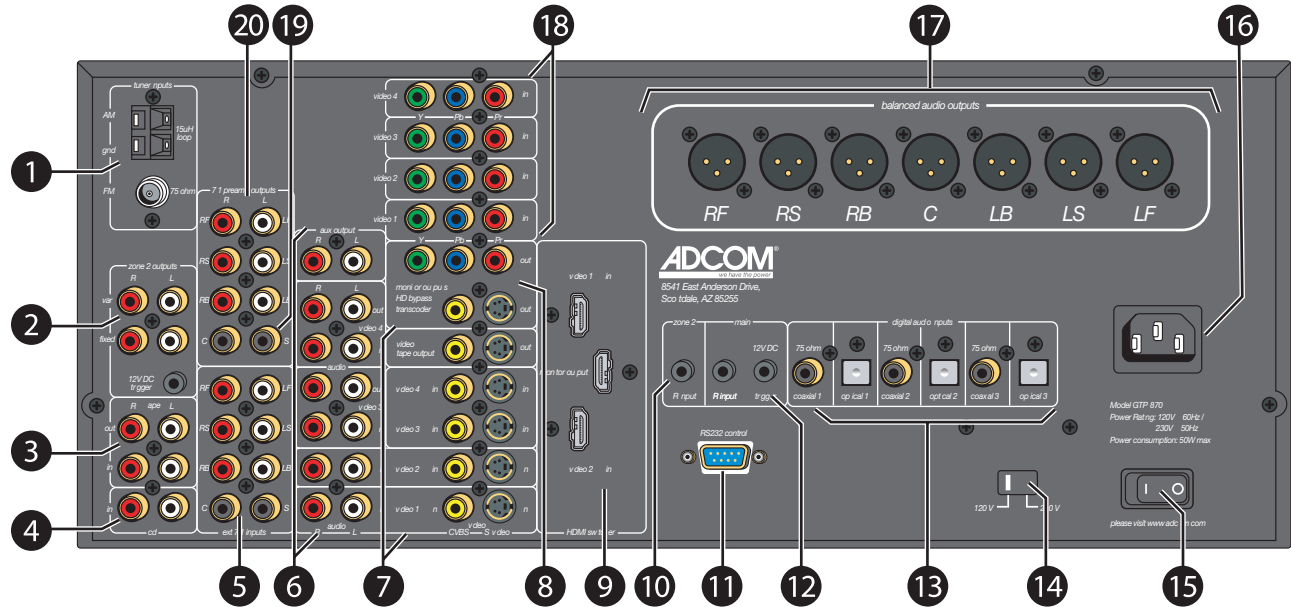

1 Tuner inputs

- **AM** - Connects to an AM loop antenna (included).
- **FM** - Connects to an FM antenna (included).

2 Zone 2 outputs

- **Variable (R/L)** - Connects to the line inputs of a power amplifier in a second room. With this connection, use the GTP-870HD remote to adjust the volume.
- **Fixed (R/L)** - Connects to the line inputs of an audio receiver in a second room. With this connection, use the secondary receiver's controls to adjust the volume.
- **12V DC trigger** - Use to power on the secondary amplifier/receiver when the Room 2 button is pressed.

3 Tape inputs/outputs

- **In (R/L)** - Connects to the line outputs of a tape player or other analog audio source component.
- **Out (R/L)** - Connects to the line inputs of a tape recorder or other analog audio recording component. Press the Tape button on the remote control or front panel to monitor the tape output.

4 CD inputs (R/L)

Connects to the line outputs of a CD player or other analog audio source component.

5 Ext 7.1 inputs

Connects to the multi-channel analog outputs of a DVD, DVD-Audio, or SACD player.

6 Analog audio inputs/outputs

- **Audio 1~4 inputs (R/L)** - Connects to the line outputs of up to four analog audio source components.
- **Audio 3~4 outputs (R/L)** - Connects to the line inputs of up to two analog audio recording components.
- **Aux output (R/L)** - Connects to the line inputs of an analog audio component.

7 Composite/S-video inputs/outputs

- **Video 1~4 inputs (CVBS/S-video)** - Connects to the Composite/S-video outputs of up to four video source components.
- **Video tape output (CVBS/S-video)** - Connects to the Composite/S-video inputs of a video recording component.

8 Monitor outputs/HD bypass transcoder

- **Video out (CVBS/S-video)** - Connects to the Composite/S-video inputs of a TV, monitor, or other display device.
- **Video out (Y/Pb/Pr)** - Connects to the Component/Progressive Scan inputs of a TV, monitor, or other display device.

9 HDMI switcher/scaler

- **Video 1~2 in** - Connects to the HDMI outputs of an HDMI-compatible source component, such as a DVD player, cable box, satellite receiver, etc.
- **Monitor output** - Connects to the HDMI inputs of an HDMI-compatible display device.

10 Zone 2 IR input

Connects to an IR remote sensor to control the GTP-870HD from Room 2.

11 RS232 control

Use to control the GTP-870HD with a PC or home automation system or to upgrade the receiver's firmware.

12 Main controls

- **Main IR input** - Use to connect a remote IR sensor to control the GTP-870HD if the front panel display is obstructed (e.g., behind closed doors).
- **Main 12V DC trigger** - Used to power on a compatible component (e.g., an amplifier/receiver or motorized screen) when the GTP-870HD is turned on. This trigger is programmable and can be associated with a specific device.

13 Digital audio inputs

- **Coaxial 1~3 (75 ohm)** - Connects to the coaxial digital audio outputs of up to three digital audio source components.
- **Optical 1~3** - Connects to the optical digital audio outputs of up to three digital audio source components.

14 Voltage switch

Sets the GTP-870HD voltage to 120V (U.S. standard) or 230 V (international standard).

15 Main power switch

Switches the GTP-870HD's main power on (1) or off (0).

16 AC input

Connects the GTP-870HD to a standard electrical outlet using the supplied power cord.

17 Balanced audio outputs

Connects to the balanced audio inputs of a power amplifier using XLR cables to feed up to seven speakers (RF/RS/RB/C/LB/LS/LF).

18 Component Video inputs

- **Video 1~4 (Y/Pb/Pr)** - Connects to the Component/Progressive Scan outputs of up to four video source components.

19 Subwoofer output

Connects to a powered subwoofer for all speaker configurations.

20 7.1 Preamp outputs

Connects to the 7.1-channel inputs of a power amplifier.

Display Overview

The following is an overview of the GTP-870HD on-screen and front panel displays.

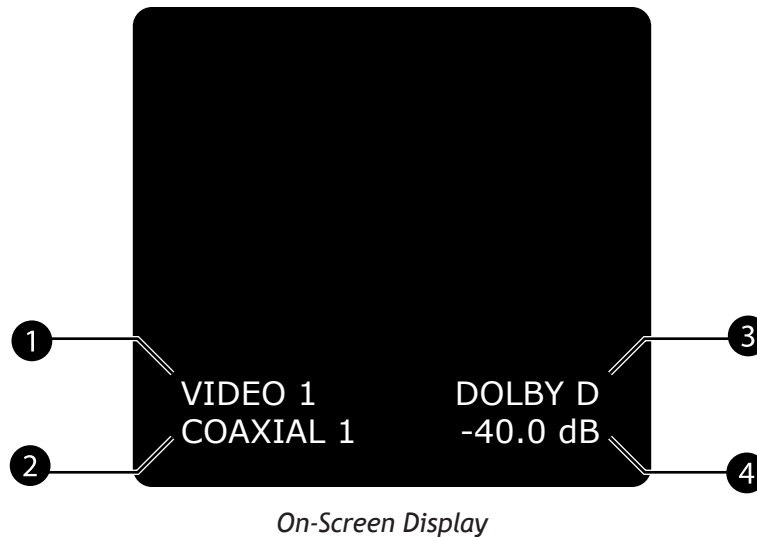

On-Screen Display

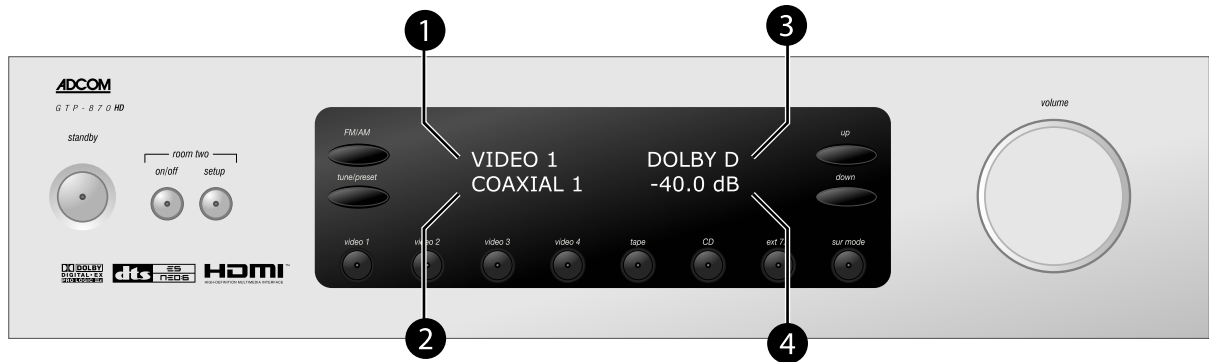

Front Panel Display

- 1 Video source**
Displays the selected video source.
- 2 Audio source**
Displays the selected audio source.
 - In Tuner mode, displays the selected tuner frequency.
- 3 Surround mode**
Displays the selected Surround mode.
 - To step through Surround modes, press the Sur Mode button on the front panel or the Mode button on the remote control.
- 4 Volume level**
Displays the selected volume level.

Notes:

- The on-screen display and front panel display show the same information; however, in setup menus only one menu item is shown at a time on the front panel display.
- The on-screen display times out after ~5 seconds.
- The front panel display remains visible at all times.
- To dim the front panel display, press the Dim button on the remote control.

Chapter 2 - Connections

Connections Overview

The GTP-870HD is the heart and soul of your entertainment system. All roads lead to it (from your input devices), and all roads lead from it (to your output devices). In this chapter, you will connect the GTP-870HD to the various components in your home theater system. These connections are presented in three stages:

Input Connections

These are the input connections for your source components, such as DVD, CD and tape players; cable boxes, satellite receivers and HDTV tuners; media PCs and iPod docking stations; or antennas for AM & FM broadcast reception:

- AM/FM antennas.....14
- Basic audio/video components (including Media PCs and iPod docking stations).....15
- DVD players16
- Component/Progressive Scan components17
- Digital audio components.....18
- HDMI components19
- External decoders.....20
- CD/Tape players.....21

Output Connections

These are the output connections for devices that display the video imagery, produce sound, or record the video and audio signals:

- TV/Monitors.....22
- Speakers23
- Amplifiers (XLR)24
- Amplifiers/Subwoofers (RCA).....24
- Video recorders26
- Tape recorders.....27
- Secondary amplifiers/receivers28

Other Connections

These are the devices that control or power your system, including:

- IR sensors.....29
- Triggers29
- PC/Control systems29
- Power sources30

Before You Begin

Before you begin connecting your devices, it is recommended that you read all instructions, including the instructions for each device you plan to connect.

- For complex setups, it is useful to draw both a logical and physical diagram of how and where you plan to set up your components.
- **DO NOT CONNECT THE GTP-870HD POWER CORD, DEVICE POWER CORDS OR TURN THE POWER TO THE GTP-870HD OR DEVICES UNTIL ALL GTP-870HD AND DEVICE CONNECTIONS ARE COMPLETE. CONNECTING OR DISCONNECTING INPUT OR OUTPUT DEVICES WHILE THE PREAMP AND/OR THE DEVICES ARE POWERED CAN RESULT IN SEVERE DAMAGE TO THE PREAMP AND/OR THE DEVICE.**

About Audio Cables

- **RCA Cables** - Use for stereo audio connections. Match red to red and white to white.
- **Digital coaxial cables** - Use for digital audio connections.
- **Digital optical cables** (aka "Toslink") - Use as an alternative to coaxial cable for digital audio connections.
- **XLR cables** - Use for amplifier connections.

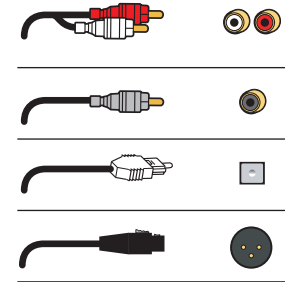

About Video Cables

- **Video cables** - Use for composite video connections. Match yellow to yellow.
- **S-Video cable** - Use for higher quality video connections to standard TVs and analog components.
- **Component video cables** - Use for best quality analog video connections to TVs and components. Match green, blue, and red respectively.
- **HDMI cables** - Use for superior, all-digital audio/video quality to and from HDMI compatible components.

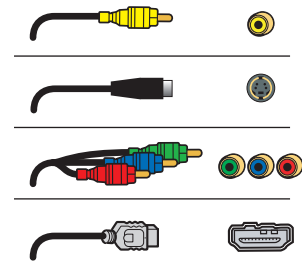

AM/FM Antenna Connections

Follow these steps to connect the supplied AM/FM antennas to the GTP-870HD.

Connecting the AM Loop Antenna

- 1 Assemble the antenna.
 - Rotate the base until it snaps into place.
- 2 Connect the antenna.
 - Locate the AM antenna inputs.
 - Press the lever next to one of the terminals and insert one of the antenna leads into the terminal. Release the lever to lock the lead in place.
 - Repeat for the other lead.
- 3 Position the antenna for best reception.
 - To mount the antenna permanently, use screws through the two holes in the base.

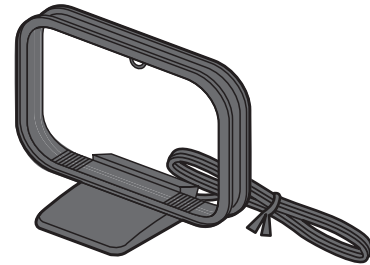

AM Loop Antenna

Connecting the FM Antenna

- 1 Assemble the antenna.
 - Connect the supplied adapter to the FM antenna as shown.
- 2 Connect the antenna.
 - Locate the FM antenna input, and securely attach the FM adapter.
- 3 Position the antenna for best reception.
 - Fully extend the antenna and experiment with its position to obtain the strongest signal. You can attach it to a wall or other surface (e.g., using push pins).
 - The supplied antenna is for indoor use only.

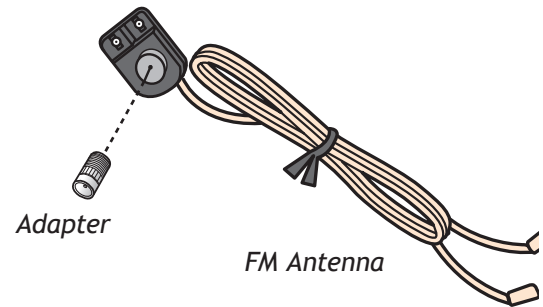

Adapter

FM Antenna

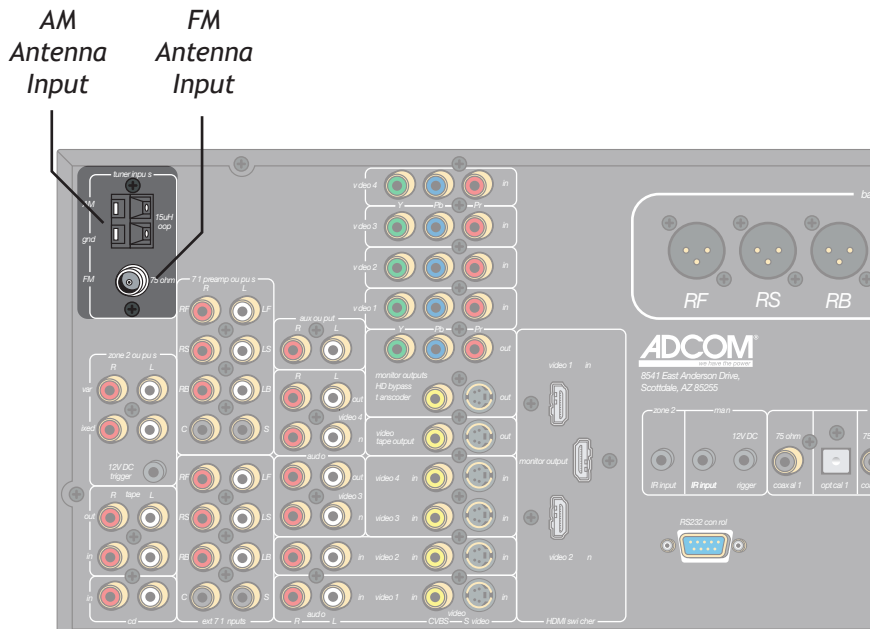

Notes:

- To switch to Tuner mode, press the Tuner button on the remote control, or the FM/AM button on the front panel.
- For Tuner operations, see page 60.

Basic Audio/Video Connections

This section provides a general connection method that is suitable for virtually any audio/video source component, including:

- DVD players
- Laser disc players
- CableTV boxes
- Satellite receivers
- HDTV set-top boxes
- VCRs (see notes below)
- PVRs
- Media PCs
- iPod docking stations

Connecting Audio/Video Components

- 1 Choose a Video input (1-4) for your component. A typical scenario might be:
 - Video 1 - DVD or Laser disc player.
 - Video 2 - Digital set-top box (CableTV, satellite receiver, or HDTV tuner).
 - Video 3 & 4 - Device with dual playback/recording capability (e.g., VCR, DVD Recorder, PVR, etc.).

- 2 Connect video.
 - Using a composite video cable, connect the video output on your source component to the video input on the GTP-870HD.
 - For higher quality video, use an S-video cable to connect the S-video output on the source component to the S-video input on the GTP-870HD.
- 3 Connect audio.
 - Using RCA cables, connect the audio outputs on your source component to the audio inputs on the GTP-870HD.
- 4 Configure your input settings.
 - See page 33.

For Advanced Connections:

Depending on the capabilities of your components, follow these links to add some sizzle to these basic connections:

- For upgraded DVD connections, see page 16.
- For Component/Progressive Scan video connections, see page 17.
- For digital audio connections, see page 18.
- For HDMI connections, see page 19.
- For recording connections, see pages 26 and 27.

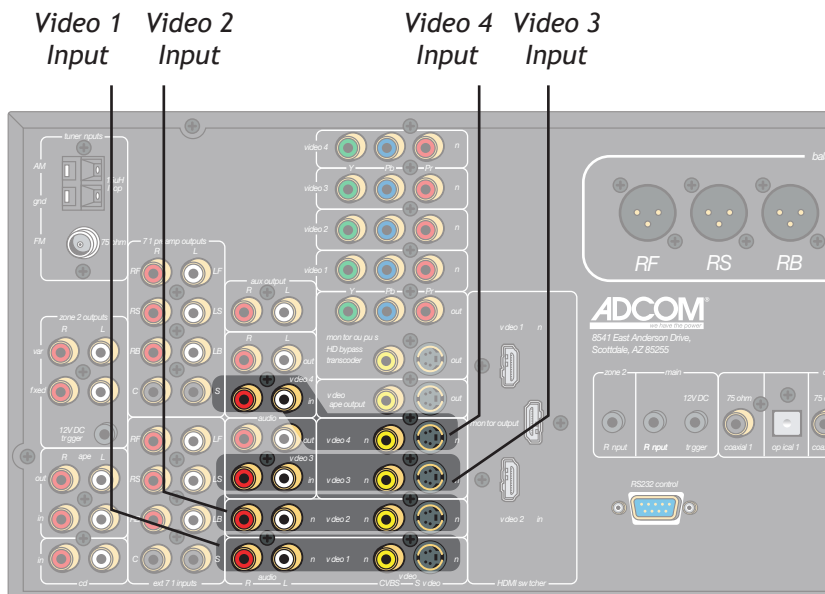

Notes:

- If you plan to use a VCR as an input device, it **MUST** have an integral Time Base Corrector!
- To select the source component you connected, press the corresponding Video 1-4 button on the remote control or front panel.
- To configure your video source, see page 33.
- For basic audio/video playback operations, see page 56.

DVD Player Connections

The GTP-870HD is a movie lover’s dream. Choose from the following special options when connecting your DVD player.

Component/Progressive Scan Connections

To take the video quality up a notch, use your DVD player’s Component/Progressive Scan outputs.

- See page 17.

Digital Audio Connections

For crystal-clear multi-channel digital audio, use your DVD player’s digital audio outputs.

- See page 18.

HDMI Connections

If your DVD player supports HDMI, you’re in for an all-digital audio/video feast.

- See page 19.

External 7.1 Connections

If your DVD player supports DVD-Audio or SACD playback, use the External 7.1 inputs.

- See page 20.

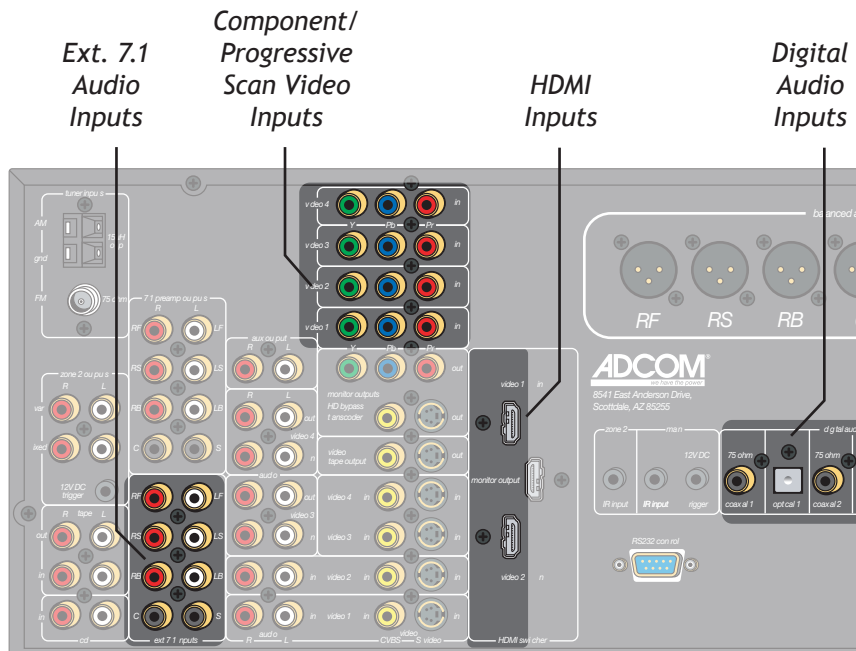

Notes:

- These superior quality connections are covered in detail on pages 17-20.

Component/Progressive Scan Connections

The GTP-870HD features four Component video inputs for connection to DVD players, digital CableTV boxes, digital satellite receivers, HDTV receivers/tuners, and more. Component video is the best quality analog connection method to an HDTV display.

Special Note on Progressive Scan DVD Players

If you want to use the GTP-870HD's built-in video scaling capability, you **MUST** set the output of your Progressive Scan DVD player to standard 480i resolution. Extended Definition (480p) and High Definition analog sources connected to the component video inputs are "bypassed" (i.e., sent to the component video output) as is—NOT scaled.

Component/Progressive Scan Connections

- 1 Choose an available Component Video input (1-4).
- 2 Connect Component video cables.
 - Using a set of Component video cables, connect the Y/Pb/Pr outputs on your source device to the corresponding Y/Pb/Pr inputs on the GTP-870HD.
 - Be sure to match the red, green, and blue connectors accordingly.

Component Video/
Progressive Scan
Inputs

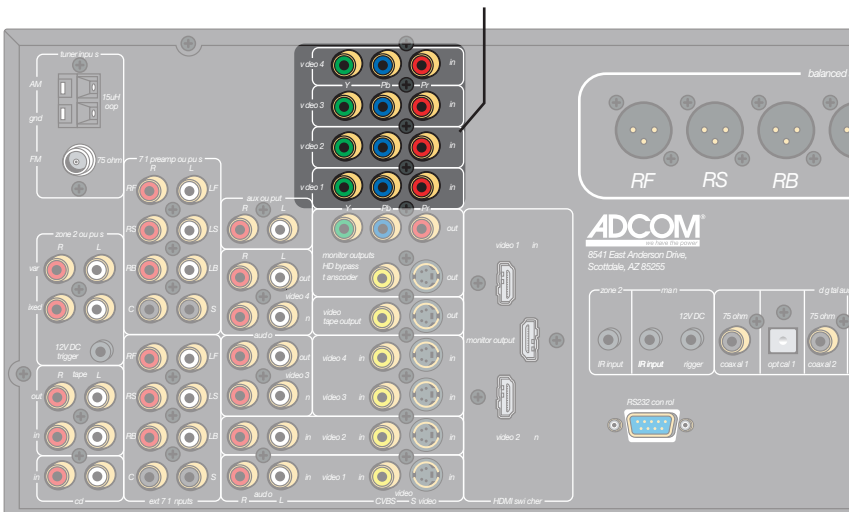

Notes:

- To select the Component/Progressive Scan inputs, press the corresponding Video 1-4 button on the remote control or front panel.
- To connect the Component/Progressive Scan outputs to your TV, see page 22.

Digital Audio Connections

The GTP-870HD features six digital audio inputs—three coaxial and three optical—to receive multi-channel bitstreams from your DVD player or other digital audio source component.

Connecting Digital Audio Components

- 1 Choose an available digital audio input.
- 2 Connect digital audio cable(s).
 - Using a digital coaxial audio cable, connect the coaxial output on your source device to the corresponding coaxial input on the GTP-870HD.
 - Alternatively, use an optical (Toslink) cable to connect the optical output on your source device to the corresponding optical input on the GTP-870HD.
- 3 Associate the digital audio input with a Video input.
 - See page 33 to associate the digital audio input with the Video 1-4 or CD input.

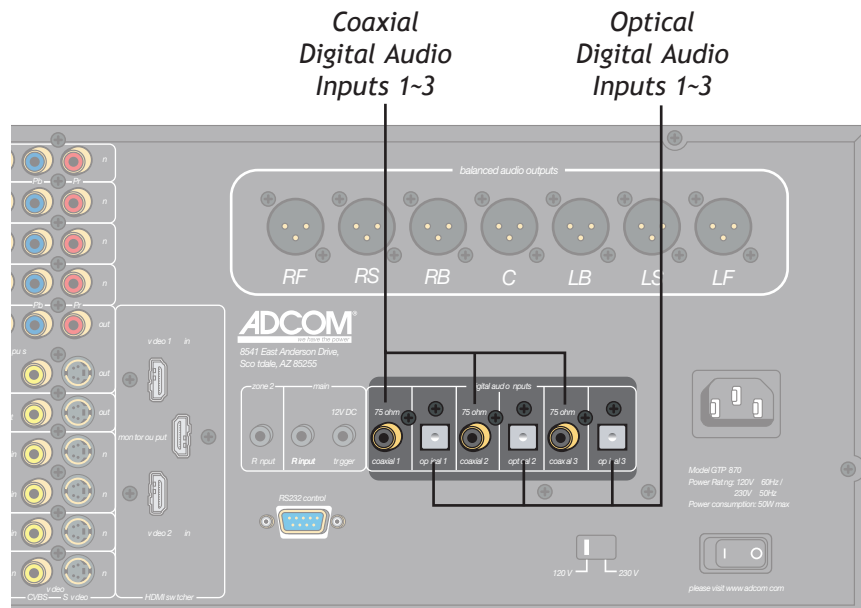

Notes:

- The digital audio inputs are assignable to the Video 1-4 or CD inputs; see page 33.

HDMI Connections

About HDMI

HDMI (High Definition Multimedia Interface) is an advanced audio/video connection method that transfers full-bandwidth, uncompressed digital audio and video signals over a single cable.

As a result, pure digital signals can pass unfettered from your HDMI-compatible source components to the GTP-870HD and out to your digital TV for superior picture and sound quality.

About the HDMI Scaler

The GTP-870HD is more than just a switch for HDMI source components. The GTP-870HD comes with a built-in scaler, a powerful video signal processor that allows you to scale the 480i or 576i NTSC/PAL inputs of your source components and output the precise resolution for your display device up to 1080p.

That means you can run your legacy video sources through the GTP-870HD to your HDMI display device through a single cable. The powerful, integrated processor deinterlaces and scales standard NTSC/PAL signals to the native resolution of your display .

Connecting HDMI Components

- 1 Choose an available HDMI input.
- 2 Connect HDMI cable(s).
 - Using an HDMI cable, connect the HDMI output on your source device to one of the HDMI inputs on the GTP-870HD.
- 3 Assign the HDMI input to an input source and configure it.
 - See pages 33-35.
- 4 Connect the HDMI output to your TV.
 - See page 22.



Tip

The HDMI connections pass both audio and video signals from your source device to your output device; however, to use the full audio processing power of the GTP-870 we recommend that you connect a separate audio cable (analog or digital) from your source device to the appropriate input on the GTP-870. See page 15 for analog audio connections or page 18 for digital audio connections.



HDMI Inputs

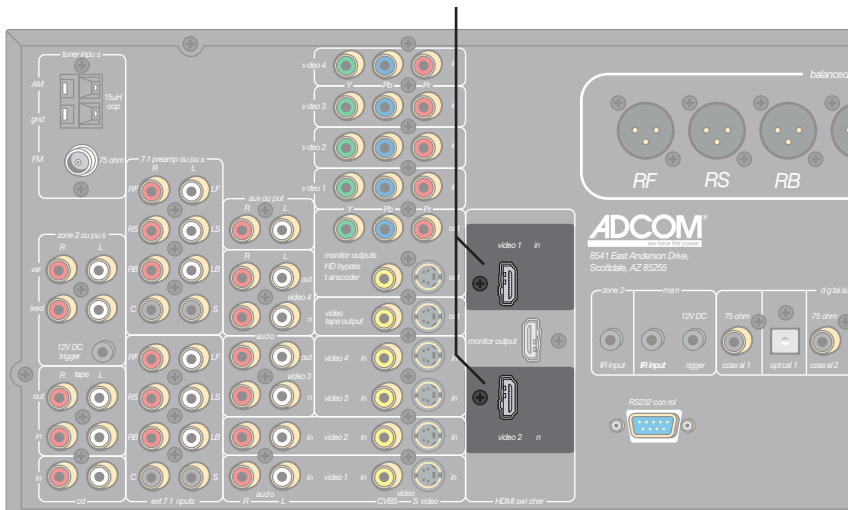

Notes:

- The HDMI inputs are assignable to any source; see page 33.
- To connect the HDMI output to your TV, see page 22.

External Decoder Connections

If you're a true audiophile, you're probably familiar with DVD-Audio and SACD, multi-channel audio formats that require their own decoding and unique connection methods. Follow these steps to connect a DVD, DVD-A, or SACD player with up to 7.1-channel analog outputs.

Connecting a DVD-A/SACD Player

- 1 Using eight RCA cables, connect the 7.1 channel analog audio outputs from your DVD player to the corresponding Ext 7.1 inputs on the GTP-870HD.
- 2 If your DVD player has 5.1-channel analog outputs, use six RCA cables and omit the RB and LB connections.



Tip

The External 7.1 inputs bypass the internal Analog to Digital Converter.

As a result, they can also be used as a "high-end" analog 2-channel input for those who desire a 'direct' analog input.

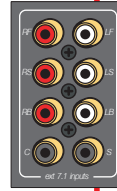

Ext. 7.1 Inputs

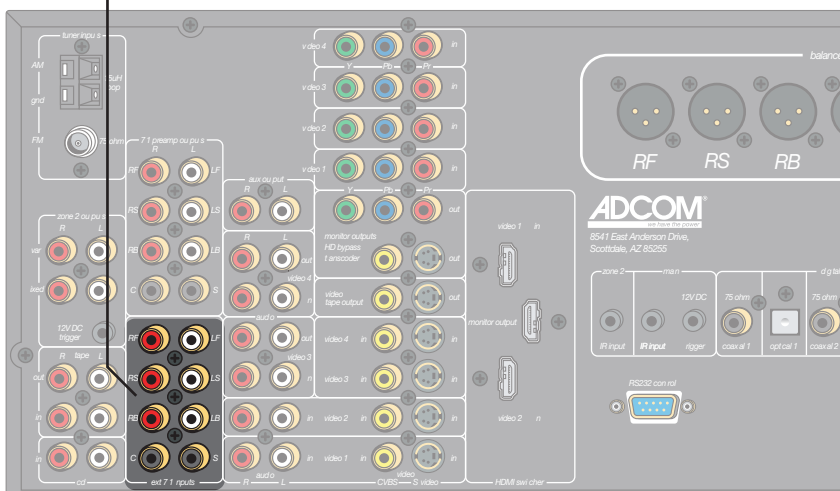

Notes:

- To switch to External 7.1 mode, press the Ext 7.1 button on the remote control or front panel.
- For Ext 7.1 operations, see page 56.

CD/Tape Player Connections

Follow these steps to connect a CD or tape player to the GTP-870HD.

Connecting a CD Player

- Using RCA cables, connect the audio outputs on your CD player to the CD inputs on the GTP-870HD.
 - If your CD player is equipped with a digital audio output (e.g. to play back a DTS CD), see Digital Audio Connections on page 18.

Connecting a Tape Player

- Using RCA cables, connect the audio outputs on your tape player to the Tape inputs on the GTP-870HD.

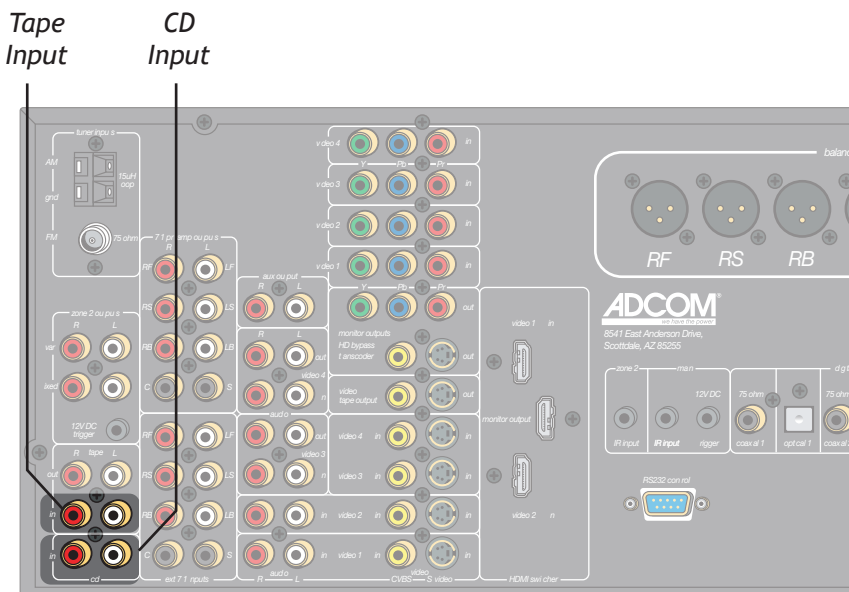

Notes:

- To switch to CD mode, press the CD button on the remote control or front panel.
- To switch to Tape mode, press the Tape button on the remote control or front panel.
- For CD configuration settings, see page 33.
- For CD operations, see page 56.
- For digital audio connections, see page 18.

TV/Monitor Connections

There are four ways to connect the GTP-870HD to a TV, monitor, or other display device:

- Composite Video
- S-Video
- Component/Progressive Scan Video
- HDMI

Composite Video Connections

- 1 Using a video cable, connect the Monitor output on the GTP-870HD to the video input on your display device.

S-Video Connections

- 1 For higher quality video, use an S-video cable to connect the Monitor output on the GTP-870HD to the S-video input on your display device.

Component Video Connections

- 1 Using a Component video cable, connect the Y/Pb/Pr outputs on the GTP-870HD to the corresponding Y/Pb/Pr inputs on your digital display device.
- 2 Be sure to match the red, green, and blue connectors accordingly.

HDMI Connections

- 1 Using an HDMI cable, connect the HDMI output on the GTP-870HD to the corresponding HDMI input on your digital display device.
- 2 The built-in HDMI switcher/scaler allows you to view both HDMI source components and upconverted legacy sources (composite, S-video, and Component video) on your digital display device.

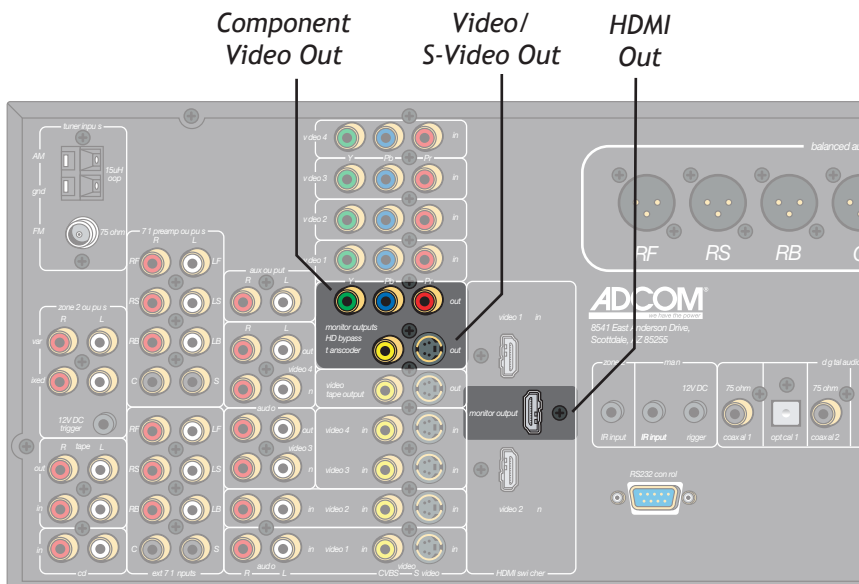

On-Screen Display (OSD) Notes:

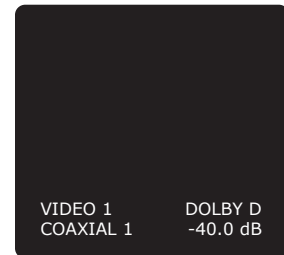

- The OSD is always available on the Composite and S-video outputs.
- The OSD is always available on the Component video outputs, EXCEPT when the input signal is higher than standard (NTSC/PAL) resolution. If so, the GTP-870HD switches from standard to bypass mode and the OSD will not appear. However, you can still access the Setup menus by pressing the Setup button (which causes the GTP-870HD to switch back to standard mode).

Speaker Placement

Placing your Speakers

To enjoy the full effect of your home theater system, it is recommended that you connect a complete set of 7.1-channel surround sound speakers, including:

- Front Speakers (LF/RF)
 - Center Speaker (C)
 - Surround Speakers (LS/RS)
 - Surround Back Speakers (LB/RB)
 - Subwoofer (S)
- } 7
— .1

If that's not possible, the next best thing is a 5.1-channel setup, including:

- Front Speakers (LF/RF)
 - Center Speaker (C)
 - Surround Speakers (LS/RS)
 - Subwoofer (S)
- } 5
— .1

Refer to the diagrams at right for approximate placement of your speakers within each of these scenarios.

While the above arrangements are ideal, the system is flexible enough to accommodate virtually any combination of speakers, with the minimum setup being two front speakers.

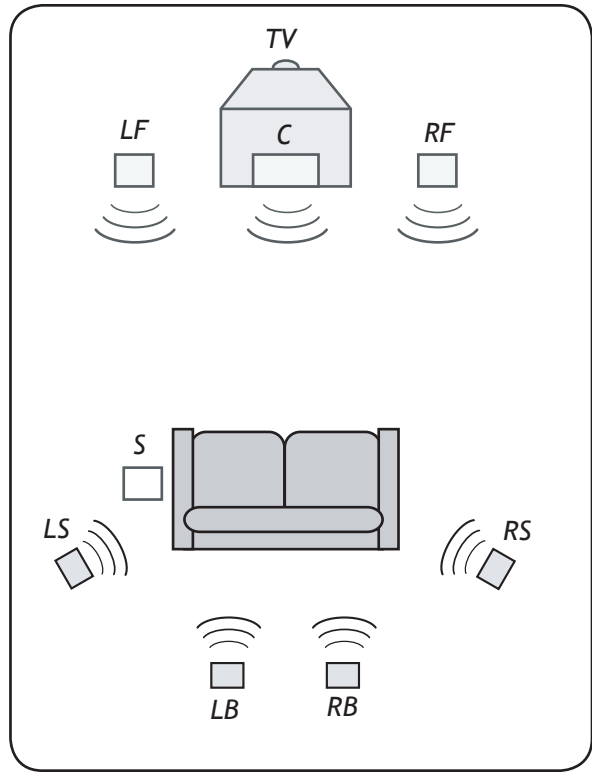

7.1 Speaker Placement

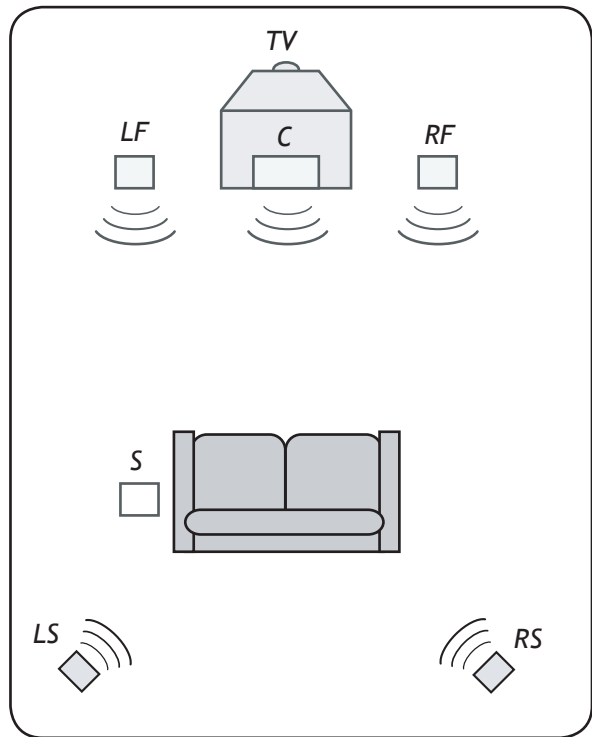

5.1 Speaker Placement

Notes:

- The best speaker placement for your particular room will depend on its size, furnishings, seating arrangement, and the acoustical properties of the space, including wall type, coverings, and various other factors.
- You will have to experiment with various placement options to determine the best configuration for your specific situation.
- If space permits, install surrounds 2-3 feet above viewers to minimize localization effects.

Amplifier Connections (XLR)

Follow these steps to connect the GTP-870HD to a power amplifier using the balanced audio outputs. Each channel is equipped with an XLR jack which allows you to enjoy professional quality sound by minimizing the effects of RF and other interference.

Connecting a 7.1-Channel Amplifier (XLR)

- Using seven XLR cables, connect the balanced audio outputs from the GTP-870HD to the corresponding XLR inputs on your amplifier.
 - LF - Left front
 - LS - Left surround
 - LB - Left back
 - C - Center
 - RB - Right back
 - RS - Right surround
 - RF - Right front
- If you have a powered subwoofer, see page 25 to complete the 7.1-channel experience.

Connecting a 5.1-Channel Amplifier (XLR)

- Using five XLR cables, connect the balanced audio outputs from the GTP-870HD to the corresponding XLR inputs on your amplifier.
 - LF - Left front
 - LS - Left surround
 - C - Center
 - RS - Right surround
 - RF - Right front
- If you have a powered subwoofer, see page 25 to complete the 5.1-channel experience.

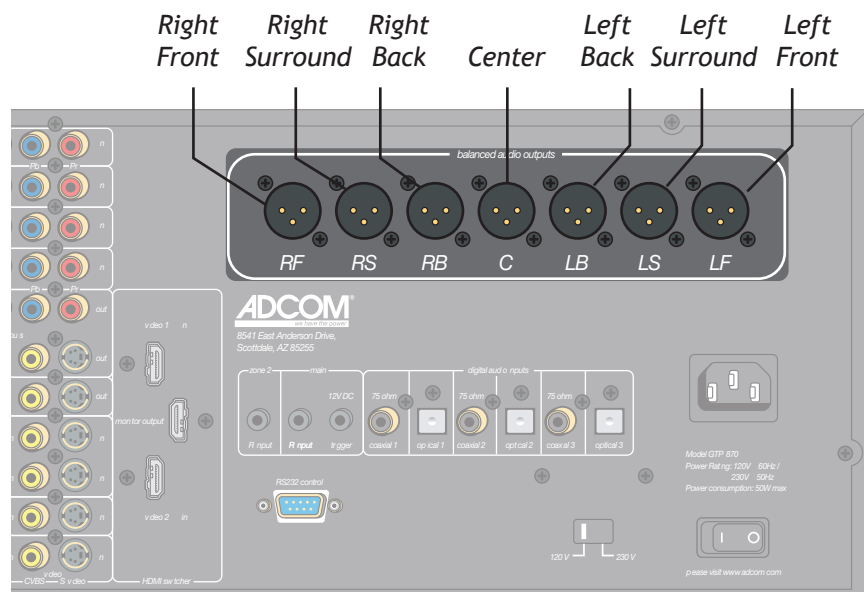

Notes:

- For subwoofer connections, see page 25.
- For 7.1 preamp connections, see page 25.
- To configure the number, size, crossover frequency, delay, and balance settings for your speakers, see pages 37-39.

Amplifier/Subwoofer Connections (RCA)

Follow these steps to connect the GTP-870HD to a power amplifier using the 7.1 preamp (unbalanced) outputs. You can also follow these steps to connect a powered subwoofer.

Connecting a 7.1-Channel Amplifier (RCA)

- 1 Using seven RCA cables, connect the 7.1 channel preamp outputs (RF, RS, RB, C, LF, LS, and LB) from the GTP-870HD to the corresponding RCA inputs on your amplifier.
- 2 Connect the S output to a powered subwoofer.

Connecting a 5.1-Channel Amplifier (RCA)

- 1 Using five RCA cables, connect the 7.1 channel preamp outputs (RF, RS, C, LF, and LS) from the GTP-870HD to the corresponding RCA inputs on your amplifier.
- 2 Connect the S output to a powered subwoofer.

Connecting a Powered Subwoofer

The “.1” in 5.1 and 7.1 stands for the all-important Subwoofer, also known as an L.F.E., or low-frequency effects channel. No home theater would be complete without a subwoofer rumbling your listening area with thunderous bass.

- 1 Using an RCA cable, connect the S output from the GTP-870HD to the corresponding RCA input on your powered Subwoofer.

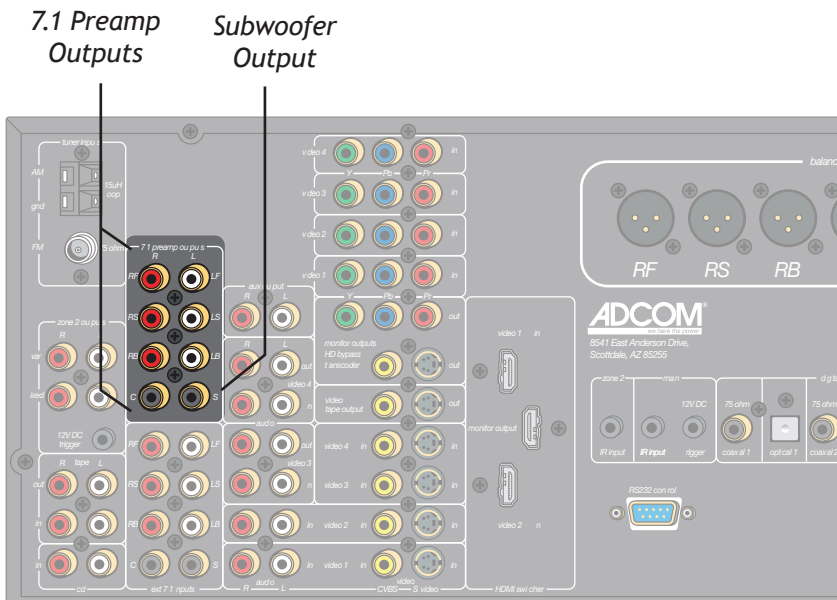

Notes:

- To configure your speakers, see pages 37-39.

Video Recorder Connections

It's not always about playback. Sometimes you want to record, and these days that means DVD recorders, HDD recorders, and PVRs (such as TiVo®), in addition to the old standby, the VCR.

Once you've connected a dual playback/record device to the Video 3 or Video 4 inputs (see page 15), follow these steps to connect the GTP-870HD back out to the device for record capability.

Connecting a Video Recorder

1. Connect video.
 - Using a video cable, connect the Video Tape output on the GTP-870HD to the video input on your video recorder.
 - For higher quality video, use an S-video cable to connect to your video recorder.
2. Connect audio.
 - Using RCA cables, connect the Video 3 or Video 4 audio outputs on the GTP-870HD to the audio inputs on your video recorder.
 - Choose Video 3 or Video 4 depending on which input your recorder is connected to.
 - If you have two video recording devices connected, you can use the Aux output for audio recording.



Tip

An alternate use of the S-Video Out is to provide video to 'legacy' video display devices. For example, you could use the S-Video out to provide input to a video processor connected to an older projector that requires an RGB input.

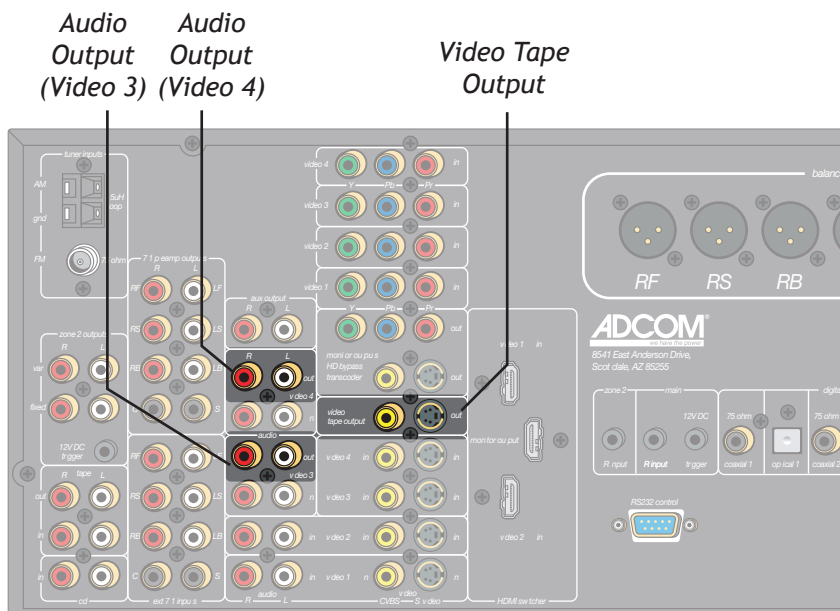

Notes:

- For tips on recording, see page 59.

Tape Out/Aux Connections

The GTP-870HD includes two additional sets of RCA outputs for connection to a tape recorder and/or audio system. Follow these steps to connect your audio output device to the GTP-870HD.

Connecting a Tape Recorder

- 1 Connect the tape recorder.
 - Using RCA cables, connect the Tape outputs on the GTP-870HD to the audio inputs on your tape recorder.
- 2 Monitor the tape recording.
 - Press the Tape button on the remote control or front panel to monitor the tape output.

Connecting an Auxiliary Audio Device

- 1 Connect the audio device
 - Using RCA cables, connect the Aux outputs on the GTP-870HD to the line inputs on your audio device.
 - The audio signal from the Aux output will switch according to the Video 1-4 or CD input.

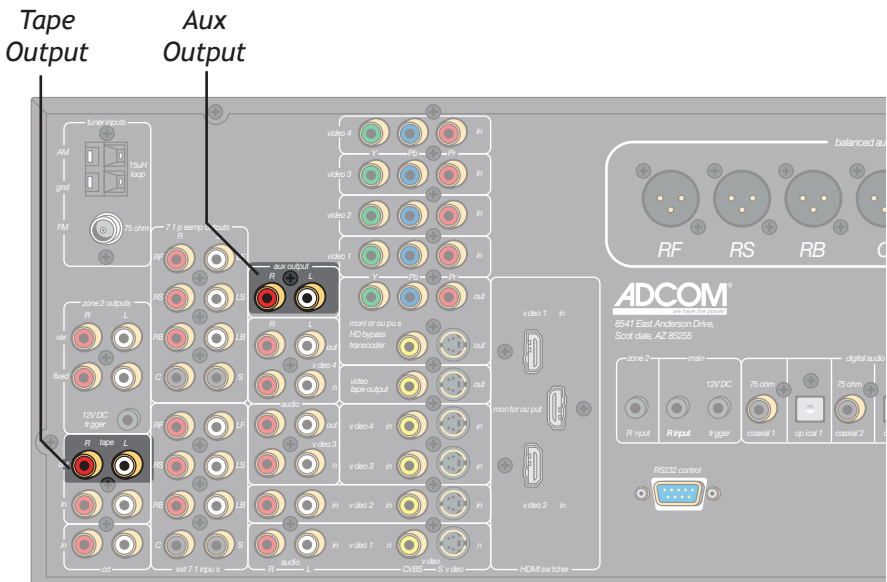

- Notes:**
- To turn the Tape Monitor on/off, press the Tape button on the remote control or front panel.
 - For Tape operations, see page 56.

Room 2 Connections

Want to listen to a CD in the den while the kids are watching a movie in the family room? Follow these steps to connect the GTP-870HD to a sound system in a second room.

Variable or Fixed Output?

Before you connect your Room 2 sound system, you need to determine whether to use the Variable or Fixed audio outputs:

- If your Room 2 sound system does NOT have its own volume control (e.g., an amplifier), use the Variable outputs and adjust the Room 2 volume from the GTP-870HD.
- If your Room 2 sound system DOES have its own volume control (e.g., a stereo receiver or other audio component), use the Fixed outputs and adjust the volume from the Room 2 device.

Connecting the Zone 2 Outputs

- 1 Connect the Room 2 amplifier/audio component.
 - Using RCA cables, connect the Var or Fixed outputs on the GTP-870HD to the line or aux inputs on your Room 2 amplifier/audio component.
 - If you are using the Fixed outputs, make sure the volume level on your external component is turned all the way down before switching to Room 2 to prevent damage to your speakers.

Connecting the 12V DC Trigger

If your external device is equipped with a 12V DC trigger, you can have the device power on automatically when you select Room 2 from the GTP-870HD.

- 1 Connect the 12V DC trigger.
 - Using a cable with two mono mini-plugs, connect the 12V DC trigger jack from the GTP-870HD to the 12V DC trigger jack on your external component.
 - Now when you press the Room 2 button, the sound system in Room 2 will power on automatically.

Connecting a Remote Sensor

If you want to be able to control the GTP-870HD while in the second room, simply connect an IR sensor to the Zone 2 remote input.

- 1 Connect the Zone 2 remote sensor.
 - Using a remote sensor with a cable long enough to reach between rooms, connect the cable's mini-plug into the Zone 2 IR input jack on the GTP-870HD.
- 2 Attach the remote sensor in Room 2.
 - Following the manufacturer's instructions, attach the remote sensor in a suitable place in Room 2.

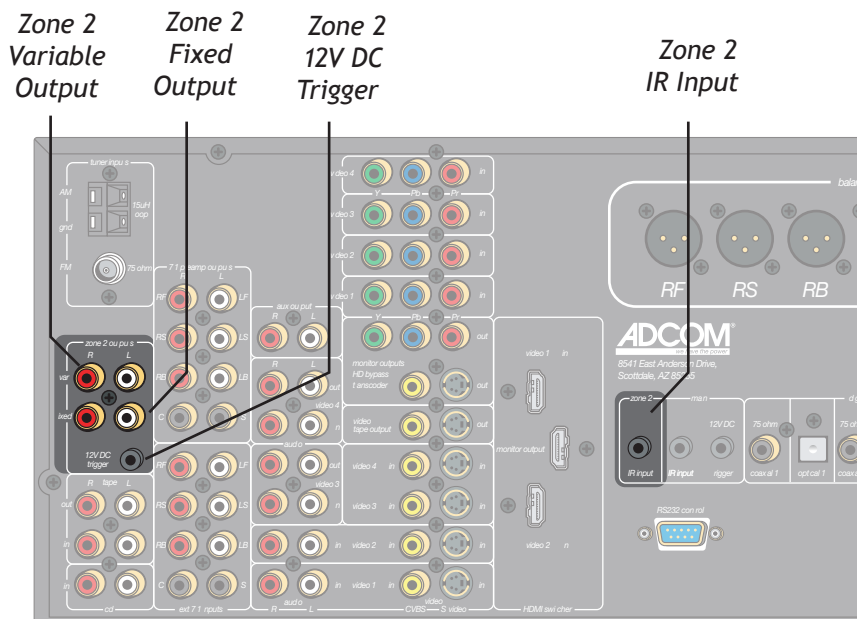

Notes:

- To switch to Room 2 mode, press the Rm 2 button on the remote control, or the Room 2 On/Off button on the front panel.
- For Room 2 configuration settings, see pages 41-42.
- For Room 2 operations, see page 62.

Control Connections

Sensors, triggers, and PCs, oh my. If you've gotten this far, you're really fine-tuning your home theater. This section is all about control:

- Remote IR sensors - These allow you to control your GTP-870HD even if it is behind closed doors or otherwise concealed from view.
- Triggers - These allow you to automatically power on connected devices, such as motorized movie screens and connected amplifiers, when the GTP-870HD is powered on or a particular input is selected.
- RS232 Port - This allows you to control the GTP-870HD with a home automation system or to upgrade the unit's firmware through the RS232 port on your PC.

Remote IR Sensor Connections

- 1 Obtain a remote IR sensor.
 - Choose a remote IR sensor from an electronics distributor that suits your particular installation needs.
 - Install the remote IR sensor according to the manufacturer's instructions.
- 3 Connect the remote IR sensor's mono mini-plug to the Main IR input on the GTP-870HD.
- 4 Confirm the remote IR sensor is working.
 - Conceal the GTP-870HD front panel and attempt to control the unit by pointing the remote at the remote IR sensor.

Screen/Power Trigger Connections

- 1 Using a cable with dual mono mini-plugs, connect the Main 12V DC trigger jack to the 12V DC trigger on your compatible device.
 - Common compatible devices include amplifiers, motorized screens, and high-end audio/video components.
- 2 Make sure the Main Trigger is enabled in the menu system; see page 33.
 - The default setting is on for all inputs.
- 3 Confirm the trigger is working.
 - Power on the GTP-870HD or select the input for which the main trigger is enabled.
 - The connected device should power on.

PC Connections

- 1 Contact Adcom for information on the availability of firmware updates and instructions for implementing them.
- 2 When instructed, use an RS232 cable to connect the RS232 port on the GTP-870HD to the RS232 port on your PC.

Media Center & Home Automation Control Systems

- 1 The RS232 port can also be used to control the GTP-870HD from a media control center, home automation system, or PC.
 - See Discrete Remote Control Commands on pages 53-54 for more information.

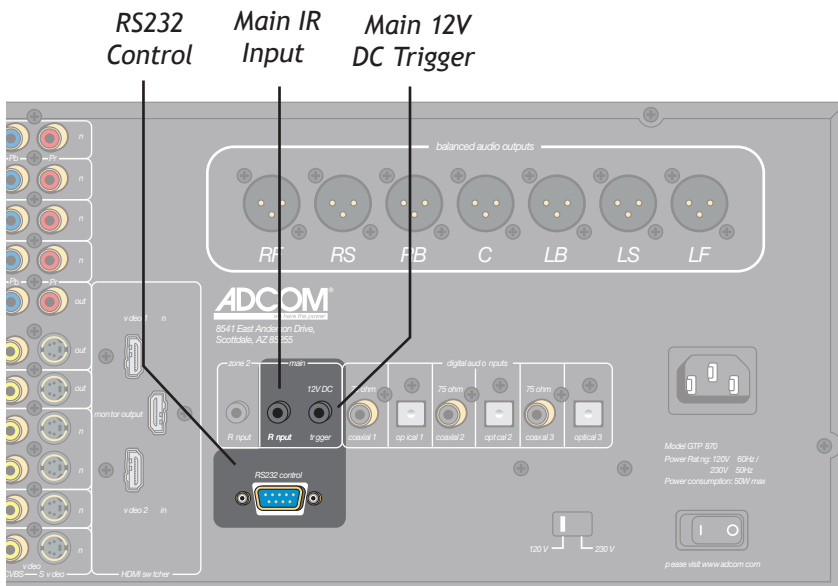

Notes:

- To configure the Main 12V DC trigger, see page 33.
- For a list of Discrete Remote Control Commands, see pages 53-54.
- The 12V trigger is simply a "trigger" and not a relay driver. Some motorized screens will require an outboard device to be used in association with the 12V trigger. See the screen manufacturer's instructions or ask your dealer or distributor.

Power Connections

When all connections are complete, you're ready to check the voltage switch, plug in the power cable, and power on the GTP-870HD.

Checking the Voltage Switch

- To prevent damage to your equipment, make sure the rear panel voltage switch is set correctly for your geographic region.
 - Select 120V for U.S. and Canada.
 - Select 230V for EU and Australia operation.
 - For other regions, check with your local authorities.

Connecting the Power Cable

- Connect the supplied power cable to the AC input and plug it into an electrical outlet.

Turning on the Power

- Turn the main power switch on.
 - Switch position (1) is on and (0) is off.
 - This switch effectively connects or disconnects the GTP-870HD from the AC power source.

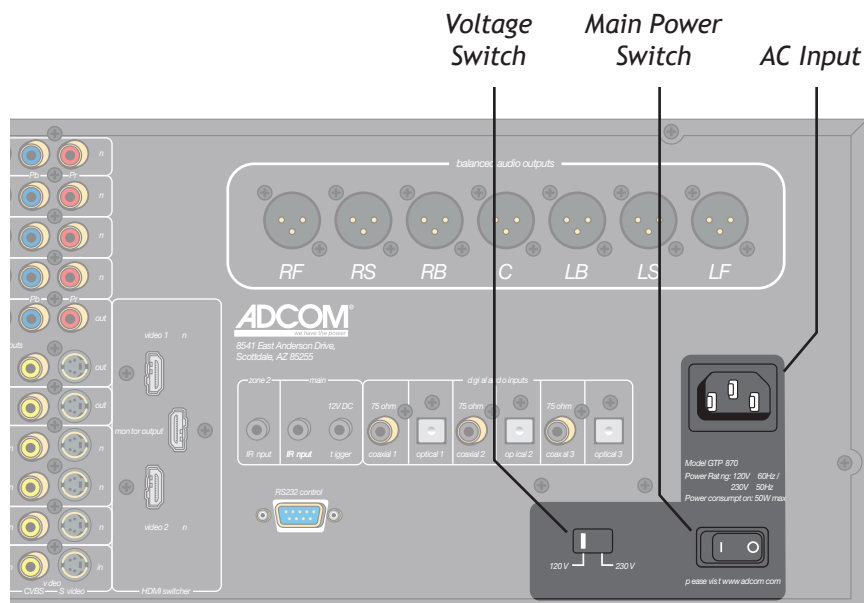
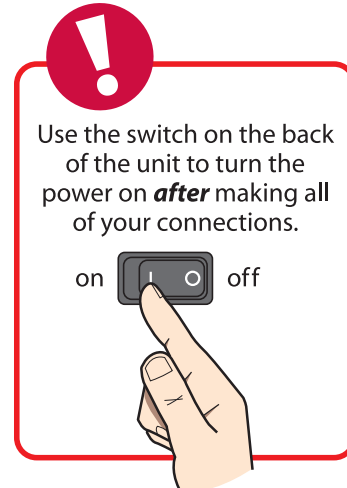

Notes:

- For system and remote setup, see Chapter 3.
- For operations, see Chapter 4.

Chapter 3 - Setup

Setup Overview

The following is an overview of the GTP-870HD Setup menu, including:

- Setup navigation 32
- Input configuration 33
- Speaker configuration 37
- Delay configuration 38
- Channel balance..... 39
- ProLogic II/Neo:6 configuration 40
- Room 2 configuration 41
- System configuration 43
- Analog input levels..... 45

For detailed remote control setup, see pages 46-54.

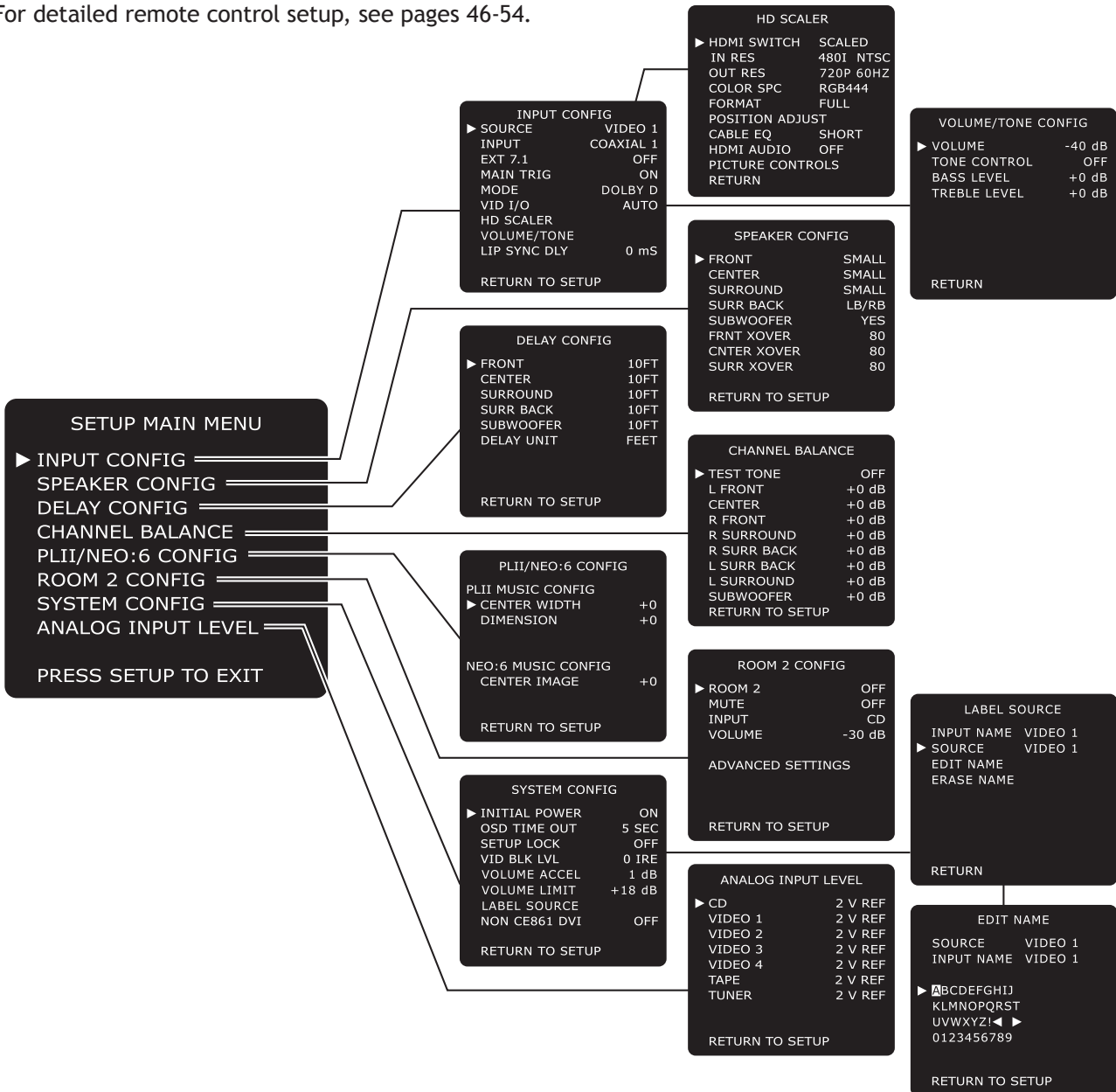

Setup Navigation

Use the following remote control buttons to navigate the Setup menu.

- **Main** - Press the Main button to select the GTP-870HD. You must first select the GTP-870HD before you can access the Setup menu.
- **Setup** - Press the Setup button to display and exit the Setup menu.
- **Arrows** - Press the \uparrow/\downarrow buttons to move the selection arrow up or down the list of menu items. Press the \leftarrow/\rightarrow buttons to step through all available options for the selected menu item.
- **Select** - Press the Select button to confirm your menu selections.

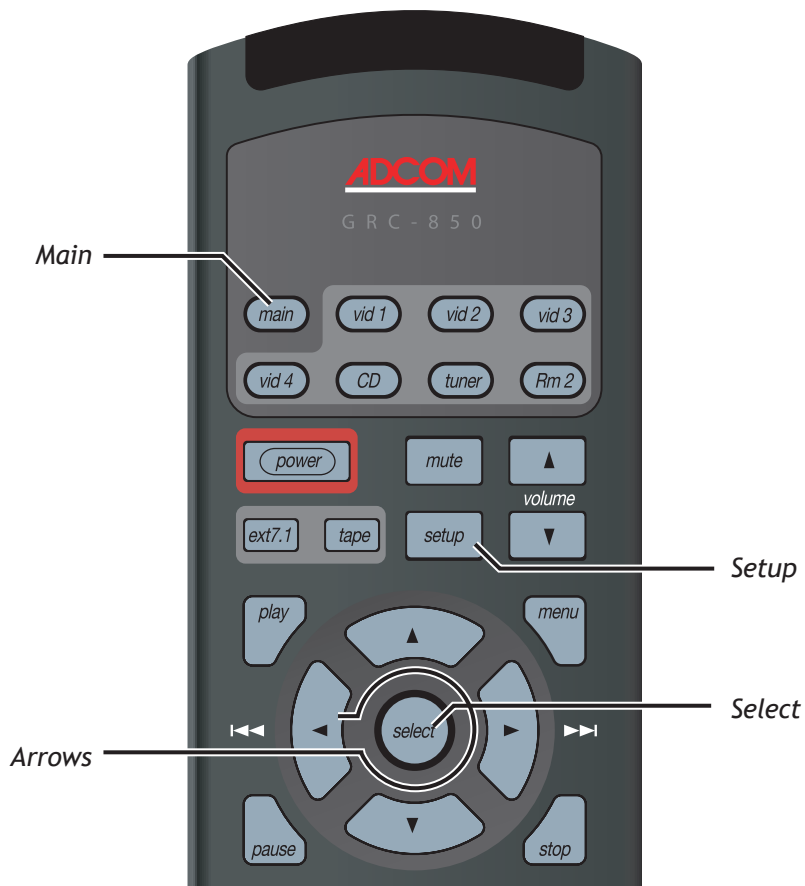

Input Configuration

What options are available when you select an input source? The following is an overview of the configuration settings available for each input.

To access the Input Configuration menu:

- 1 Press the Main button on the remote control.
- 2 Press the Setup button.
- 3 Use the \blacktriangle / \blacktriangledown buttons to select INPUT CONFIG, then press the Select button.
- 4 Use the \blacktriangle / \blacktriangledown buttons to choose from the following menu items:

SOURCE

Selects the input source you are configuring. Use the \blacktriangle / \blacktriangleright buttons to select:

- Video 1, Video 2, Video 3, Video 4, CD, Tuner AM, or Tuner FM

INPUT

Selects the audio input that you wish to assign to the selected input source. Use the \blacktriangle / \blacktriangleright buttons to select:

- Coaxial 1, Coaxial 2, Coaxial 3, Optical 1, Optical 2, Optical 3, or Analog

EXT 7.1

Enables or disables the External 7.1 inputs for the selected input source. Use the \blacktriangle / \blacktriangleright buttons to select:

- On or Off

MAIN TRIG

Enables or disables the Main 12V DC Trigger for the selected input source. If the input source has a 12V DC Trigger input, you can use this setting to automatically power the source device on whenever this input is selected. Use the \blacktriangle / \blacktriangleright buttons to select:

- On or Off

MODE

Selects the default Surround mode for the selected input. Use the \blacktriangle / \blacktriangleright buttons to select:

- 7.1 m², Dolby Digital, Dolby Digital EX, DTS, DTS-ES, Neo:6 C, Neo:6 M, Dolby Pro Logic, Stereo, Pro Logic II-C, Pro Logic II-M, Pro Logic II-P, Pro Logic IIX-C, Pro Logic IIX-M, Pro Logic IIX-P, Hall, or 5 Stereo
- For a detailed description of each Surround mode, see page 57.

VID I/O

Selects the video source you wish to assign to the selected input. Use the \blacktriangle / \blacktriangleright buttons to select:

- Auto, Composite, S-video, Component, or Bypass
- If you select Auto, the GTP-870HD will automatically detect which video input jacks are in use.

INPUT CONFIG	
▶ SOURCE	VIDEO 1
INPUT	COAXIAL 1
EXT 7.1	OFF
MAIN TRIG	ON
MODE	DOLBY D
VID I/O	AUTO
HD SCALER	
VOLUME/TONE	
LIP SYNC DLY	0 mS
RETURN TO SETUP	

- If you select Bypass, the Setup menu and on-screen displays will not be shown. Once Bypass has been selected, you will need to use the Setup menu on the front panel display in order to change this setting.

HD SCALER

Displays the HD (High Definition) Scaler menu.

- See page 34.

VOLUME/TONE

Displays the Volume/Tone Configuration menu.

- See page 36.

LIP SYNC DLY

Sets the default lip sync delay for the selected input. Use this feature if video processing is causing the video to lag behind the audio. Use \blacktriangle / \blacktriangleright to set the lip sync delay:

- The available range is 0 to 169 mS.
- The default setting is 0 mS.

Notes:

- For 'on the fly' adjustments to the lip sync delay, press the Sync button on the remote control, then use \blacktriangle / \blacktriangleright to override the default delay setting.
- While the Lip Sync Delay menu is displayed, press the Sync button again to toggle the delay on and off. This allows you to make quick comparisons with and without delay.

HD Scaler Configuration

Now it's time to enable the HD Scaler and configure it for your display and source devices.

To access the HD Scaler menu:

- 1 Press the Main button on the remote control.
- 2 Press the Setup button.
- 3 Use the $\blacktriangle/\blacktriangledown$ buttons to select INPUT CONFIG, then press the Select button.
- 4 Use the $\blacktriangle/\blacktriangledown$ buttons to select HD SCALER, then press the Select button.
- 5 Use the $\blacktriangle/\blacktriangledown$ buttons to choose from the following menu items:

HDMI SWITCH

Enables the HD Scaler or simply passes through the HDMI signal. Use the $\blacktriangle/\blacktriangleright$ buttons to select:

- Scaled - Enables the HD Scaler for the selected input.
- Video 1, Video 2 - Assigns the Video 1 or Video 2 HDMI input to the selected input.
- None - Disables HDMI for the selected input.

IN RES

Specifies the input resolution for the HD scaler. Use the $\blacktriangle/\blacktriangleright$ buttons to select:

- 480i NTSC or 576i PAL.

OUT RES

Sets the output resolution of the HD Scaler to match your display device. Check the specifications of your display, then use the $\blacktriangle/\blacktriangleright$ buttons to choose from the following:

- Select 480i or 576i for standard NTSC or PAL interlaced displays.
- Select 480p, 576p, 720p (50/60Hz), 1080i, 1080p (50/60Hz) or VGA for high-definition and/or progressive scan displays.
- Select Auto to automatically detect the output resolution of your display device.

COLOR SPC

Specifies the 24-bit color space output to your display device. Check the specifications of your display, then use the $\blacktriangle/\blacktriangleright$ buttons to select:

- RGB444 (default) or YCbCr444

FORMAT

Sets the default picture format for the selected input. Use the $\blacktriangle/\blacktriangleright$ buttons to choose:

- **Auto** - Automatically selects the best picture format for the current output resolution.
- **Full** - Stretches a standard 4:3 image to fill a widescreen (16:9) display.
- **Zoom** - Zooms the on-screen image proportionally, preserving the original aspect ratio but cropping the picture.

HD SCALER

▶ HDMI SWITCH	SCALED
IN RES	480I NTSC
OUT RES	720P 60HZ
COLOR SPC	RGB444
FORMAT	FULL
POSITION ADJUST	
CABLE EQ	SHORT
HDMI AUDIO	OFF
PICTURE CONTROLS	
RETURN	

- **Squeeze** - Compresses a widescreen image to a 4:3 display.
- **NLS (Non-linear Stretch)** - Stretches a 4:3 image to 16:9, but preserves the correct aspect ratio in the center of the picture.

POSITION ADJUST

Displays the Position Adjust menu where you can fine tune the vertical and horizontal position of the scaled image. Use the $\blacktriangle/\blacktriangleright$ buttons to select:

- Test Patrn - Displays a test pattern to make it easier to discern the edges of the screen.
- Vert Position - Set from -31 to +31.
- Horz Position - Set from -63 to +63.

CABLE EQ

Enables cable equalization to compensate for high-frequency signal loss/dispersion when transmitting high-res video over long distances. Use the $\blacktriangle/\blacktriangleright$ buttons to select:

- Short or Long
- Select Short if your HDMI cable is < 5 meters.
- Select Long if your HDMI cable is > 5 meters.

HDMI AUDIO

Sets the format of the HDMI audio signal. Leave this setting off UNLESS you are using your display's integrated audio processing, amplification and speakers. If this setting is on, you will NOT be using the GTP-870HD audio processor and amplifier. Use the $\blacktriangle/\blacktriangleright$ buttons to select:

- PCM 2 CH, PCM/Bit, or Off
- Select PCM 2CH to send a 2-channel digital audio signal to your display device.
- Select PCM/Bit to send a digital bitstream to your display device.
- Select Off to disable HDMI audio.

PICTURE CONTROLS

See page 35.

Picture Controls

The HD Scaler includes basic and advanced controls to help you achieve optimal picture quality for each input source.

To access the Picture Controls menu:

- 1 Press the Main button on the remote control.
- 2 Press the Setup button.
- 3 Use the ▲/▼ buttons to select INPUT CONFIG, then press the Select button.
- 4 Use the ▲/▼ buttons to select HD SCALER, then press the Select button.
- 5 Use the ▲/▼ buttons to select PICTURE CONTROLS, then press the Select button.
- 6 Use the ▲/▼ buttons to choose from the following menu items:

BASIC CONTROLS

Provides basic tools to adjust the picture for each input source. Use the ◀/▶ buttons to choose:

- **Contrast** - Adjusts the difference in brightness between the lightest and darkest areas of the picture. Choose from 0-20 (default = 10).
- **Brightness** - Adjusts the overall brightness of the picture. Choose from 0-100 (default = 50).
- **Color** - Adjusts the color intensity and saturation of the picture. Choose from 0-128 (default = 64).
- **Tint** - Adjusts red and green levels to accurately reproduce skin tones. Choose from 0-100 (default = 50).
- **ACE** (Adaptive Color Enhancement) - Enhances an image by improving its contrast. Choose from High, Mid, Low, or Off (default).
- **Edge** - Adjusts edge enhancement, ranging from soft to crisp picture detail. Choose from High, Mid, Low, or Off (default).

ADVANCED CONTROLS

Provides advanced tools to fine-tune the picture for each input source. Use the ◀/▶ buttons to choose:

- **Noise Filter** - Provides a variety of specialized filters to reduce picture noise (see table at right).
- **Deinterlace Mode** - Digitally enhances the picture quality of interlaced source material (see table at right).
- **Film Mode** - Automatically detects if source material was originally shot on film and transferred to video, e.g. DVDs, VHS tapes, and many TV programs. Choose from Auto or Off.

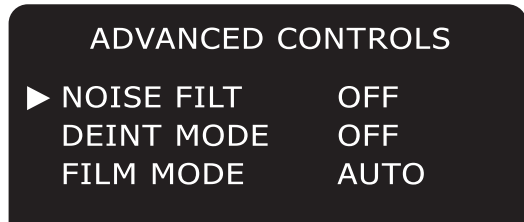
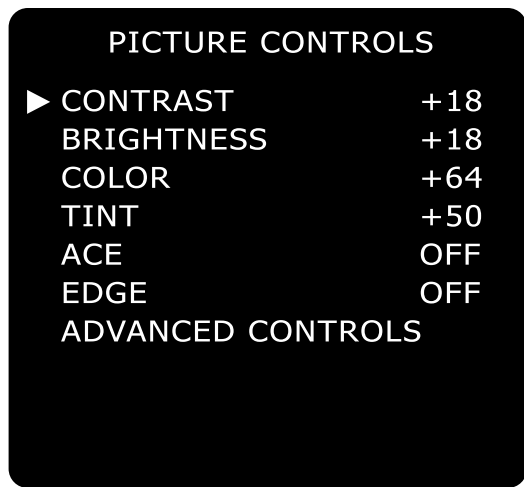

Noise Reduction Filters	• 3D A-FTD	Multiple Frame Adaptive Filter with Flesh Tone Detection
	• 3D A	Multiple Frame Adaptive Filter
	• 3D F-FTD	Multiple Frame Fixed Filter with Flesh Tone Detection
	• 3D FIXED	Multiple Frame Fixed Filter
	• 2D C-FTD	Single Frame Cascade Filter with Flesh Tone Detection
	• 2D C	Single Frame Cascade Filter
	• OFF	No Noise Reduction

Deinterlace Modes	• 3D MA V1	Multiple Frame/Motion Adaptive/Vector Interpolation
	• 3D MA V2	Multiple Frame/Motion Adaptive/No Vector Interpolation
	• 3D MA LN	Multiple Frame/Motion Adaptive/Linear
	• 3D	Multiple Frame/No Vector Interpolation
	• 2D VX1	Single Frame/Vector Interpolation
	• 2D VX2	Single Frame/No Vector Interpolation
	• 2D LN	Single Frame/Linear
	• OFF	No Deinterlacing

Volume/Tone Configuration

Want to adjust the bass, treble, and relative volume for each input source? Look no further than the Volume/Tone Configuration menu.

To access the Volume/Tone Configuration menu:

- 1 Press the Main button on the remote control.
- 2 Press the Setup button.
- 3 Use the $\blacktriangle/\blacktriangledown$ buttons to select INPUT CONFIG, then press the Select button.
- 4 Use the $\blacktriangle/\blacktriangledown$ buttons to select VOLUME/TONE, then press the Select button.
- 5 Use the $\blacktriangle/\blacktriangledown$ buttons to choose from the following menu items:

VOLUME

Sets the relative volume of the selected input. Use this feature to balance volume levels as you switch between inputs. Use the $\blacktriangle/\blacktriangledown$ buttons to set the volume level:

- The available range is -80 dB to +18 dB.
- The default setting is -40 dB.

TONE CONTROL

Enables manual bass and treble control. Use the $\blacktriangle/\blacktriangledown$ buttons to choose:

- On or Off.
- Select On to use your custom bass and treble settings for the selected input.
- Select Off to use the default bass and treble settings for the selected input.

BASS LEVEL

Provides manual control of the bass level for the selected input. Use the $\blacktriangle/\blacktriangledown$ buttons as follows:

- The available range is -12 dB to +12 dB.
- The default setting is +0 dB.

TREBLE LEVEL

Provides manual control of the treble level for the selected input. Use the $\blacktriangle/\blacktriangledown$ buttons as follows:

- The available range is -12 dB to +12 dB.
- The default setting is +0 dB.

VOLUME/TONE CONFIG

▶ VOLUME	-40 dB
TONE CONTROL	OFF
BASS LEVEL	+0 dB
TREBLE LEVEL	+0 dB

RETURN

Notes:

- To make Bass/Treble adjustments 'on the fly,' first press the Bypass button on the remote control to toggle Tone Control on. Then use the Bass and Treble buttons to bring up the tone adjustment on-screen display. Finally, use the $\blacktriangle/\blacktriangledown$ buttons to set the desired level.
- Tone controls are not available in the Dolby Digital EX, DTS-ES, NEO6, and Pro Logic IIx Surround modes.

Speaker Configuration

What speaker types and sizes are you using? The following is an overview of the Speaker Configuration menu.

To access the Speaker Configuration menu:

- 1 Press the Main button on the remote control.
- 2 Press the Setup button.
- 3 Use the \blacktriangle / \blacktriangledown buttons to select SPEAKER CONFIG, then press the Select button.
- 4 Use the \blacktriangle / \blacktriangledown buttons to choose from the following menu items:

FRONT

Selects the relative size of your front speakers. Use the \blacktriangle / \blacktriangledown buttons to select:

- Small or Large
- Select Small if you DO have a subwoofer.
- Select Large if you do NOT have a subwoofer.

CENTER

Selects the relative size of your center speaker (if applicable). Use the \blacktriangle / \blacktriangledown buttons to select:

- Small, Large, or None
- Select Small if you DO have a subwoofer.
- Select Large if you do NOT have a subwoofer.
- Select None if you do not have a center speaker.

SURROUND

Selects the relative size of your surround speakers (if applicable). Use the \blacktriangle / \blacktriangledown buttons to select:

- Small, Large, or None
- Select Small if you DO have a subwoofer.
- Select Large if you do NOT have a subwoofer.
- Select None if you do not have a surround speaker.

SURR BACK

Indicates the presence and configuration of your surround back speakers. Use the \blacktriangle / \blacktriangledown buttons to select:

- BS-LB, LB/RB, or None
- Select BS-LB if you have a SINGLE surround back speaker (BS) connected to the left back (LB) output.
- Select LB/RB if you have TWO surround back speakers connected to the left back (LB) and right back (RB) outputs, respectively.
- Select None if you do NOT have surround back speakers.

SPEAKER CONFIG

▶ FRONT	SMALL
CENTER	SMALL
SURROUND	SMALL
SURR BACK	LB/RB
SUBWOOFER	YES
FRNT XOVER	80
CNTR XOVER	80
SURR XOVER	80

RETURN TO SETUP

SUBWOOFER

Indicates the presence of a subwoofer. Use the \blacktriangle / \blacktriangledown buttons to select:

- Yes or No
- Select Yes if you DO have a Subwoofer.
- Select No if you do NOT have a Subwoofer

FRNT XOVER

Sets the front speaker crossover frequency; i.e., the frequency (in Hz) at which audio signals are routed from your front speakers to the subwoofer. Use the \blacktriangle / \blacktriangledown buttons to select:

- 40, 60, 80, 100, 120, 150
- If you set your front speakers to Large, then this setting will be fixed at None.

CNTR XOVER

Sets the center speaker crossover frequency; i.e., the frequency (in Hz) at which audio signals are routed from your center speaker to the subwoofer. Use the \blacktriangle / \blacktriangledown buttons to select:

- 40, 60, 80, 100, 120, 150
- If you set your center speakers to Large, then this setting will be fixed at None.

SURR XOVER

Sets the surround speaker crossover frequency; i.e., the frequency (in Hz) at which audio signals are routed from your surround speakers to the subwoofer. Use the \blacktriangle / \blacktriangledown buttons to select:

- 40, 60, 80, 100, 120, 150
- If you set your surround speakers to Large, then this setting will be fixed at None.

Delay Configuration

How far is each speaker from your primary listening area? The GTP-870HD uses this information to calculate differences in distance and adds milliseconds of delay if necessary to ensure that all audio signals reach your ears simultaneously from all speakers. The following is an overview of the Delay Configuration menu.

To access the Delay Configuration menu:

- 1 Press the Main button on the remote control.
- 2 Press the Setup button.
- 3 Use the ▲/▼ buttons to select DELAY CONFIG, then press the Select button.
- 4 Use the ▲/▼ buttons to choose from the following menu items:

FRONT

Sets the distance from your front speakers to your primary listening area in feet or meters (see Delay Unit below). Measure this distance, then use the ◀/▶ buttons to select:

- 0-20 feet (0-6.1 meters)
- The front distance is the benchmark setting for all other speakers, so measure this distance carefully.

CENTER

Sets the distance from your center speaker to your primary listening area in feet or meters (see Delay Unit below). Measure this distance, then use the ◀/▶ buttons to select:

- 0-20 feet (0-6.1 meters)
- The center speaker is often closer to the primary listening area than the front speakers. If so, the GTP-870HD calculates the difference in distance and adds delay accordingly.

SURROUND

Sets the distance from your surround speakers to your primary listening area in feet or meters (see Delay Unit below). Measure this distance, then use the ◀/▶ buttons to select:

- 0-20 feet (0-6.1 meters)
- The surround speakers are often closer to the primary listening area than the front speakers. If so, the GTP-870HD calculates the difference in distance and adds delay accordingly.

DELAY CONFIG	
▶ FRONT	10FT
CENTER	10FT
SURROUND	10FT
SURR BACK	10FT
SUBWOOFER	10FT
DELAY UNIT	FEET
RETURN TO SETUP	

SURR BACK

Sets the distance from your surround speakers to your primary listening area in feet or meters (see Delay Unit below). Measure this distance, then use the ◀/▶ buttons to select:

- 0-20 feet (0-6.1 meters)
- The surround back speakers are often closer to the primary listening area than the front speakers. If so, the GTP-870HD calculates the difference in distance and adds delay accordingly.

SUBWOOFER

Sets the distance from your subwoofer to your primary listening area in feet or meters (see Delay Unit below). Measure this distance, then use the ◀/▶ buttons to select:

- 0-20 feet (0-6.1 meters)
- The subwoofer is often closer to the primary listening area than the front speakers. If so, the GTP-870HD calculates the difference in distance and adds delay accordingly.

DELAY UNIT

Sets the unit of measurement for channel delays. Use the ◀/▶ buttons to select:

- Feet or Meters.

Channel Balance

How can you achieve optimal balance in volume levels from all speakers? The GTP-870HD supplies individual sliders and a “pink noise” test tone to aid you in balancing your speaker levels. For best results, it is recommended that you use a Sound Pressure Level (SPL) meter to precisely measure the volume levels from each speaker. However, your ear aided by experimentation is ultimately the best judge. The following is an overview of the Channel Balance menu.

To access the Channel Balance menu:

- 1 Press the Main button on the remote control.
- 2 Press the Setup button.
- 3 Use the ▲/▼ buttons to select CHANNEL BALANCE, then press the Select button.
- 4 Use the ▲/▼ buttons to choose from the following menu items:

TEST TONE

Generates a “pink noise” test tone that you can move manually from speaker to speaker. This neutral tone provides an effective gauge to measure volume levels that is more objective than a movie sound track or other variable signal. Use the ◀/▶ buttons to select:

- On or Off
- If you select On, the test tone does not begin until you first select a speaker (see below).
- If you select Off, the currently selected audio source will be heard instead of the test tone.

L FRONT / R FRONT

Adjusts the relative volume of the left/right front speakers. Use the ◀/▶ buttons to select:

- -10 to +10 dB

CENTER

Adjusts the relative volume of the center speaker. Use the ◀/▶ buttons to select:

- -10 to +10 dB
- If you do not have a center speaker (as set on page 37), the choice will be fixed to N/A.

CHANNEL BALANCE

▶ TEST TONE	OFF
L FRONT	+0 dB
CENTER	+0 dB
R FRONT	+0 dB
R SURROUND	+0 dB
R SURR BACK	+0 dB
L SURR BACK	+0 dB
L SURROUND	+0 dB
SUBWOOFER	+0 dB
RETURN TO SETUP	

L SURROUND / R SURROUND

Adjusts the relative volume of the left/right surround speakers. Use the ◀/▶ buttons to select:

- -10 to +10 dB
- If you do not have surround speakers (as set on page 37), the choices will be fixed to N/A.

L SURR BACK / R SURR BACK

Adjusts the relative volume of the left/right surround back speakers. Use the ◀/▶ buttons to select:

- -10 to +10 dB
- If you do not have surround back speakers (as set on page 37), the choices will be fixed to N/A.

SUBWOOFER

Adjusts the relative volume of the subwoofer. Use the ◀/▶ buttons to select:

- -10 to +10 dB
- If you do not have a subwoofer (as set on page 37), the choices will be fixed to N/A.

Notes:

- You can also use the Channel Trim and Test Tone buttons on the remote control to adjust the channel balance.
- Press the Channel Trim button to set the volume levels for each individual speaker.
- Press the Test Tone button to hear a test tone in each speaker.

Pro Logic IIx/Neo:6 Configuration

The GTP-870HD makes the most of your incoming stereo signals. With the built-in Dolby Pro Logic IIx and DTS Neo:6 decoders, not only can you slice, dice, and expertly distribute a stereo signal to seven or more speakers, you can even fine-tune the imaging and depth of the sound field specifically for music sources.

To access the Pro Logic IIx/Neo:6 configuration menu:

- 1 Press the Main button on the remote control.
- 2 Press the Setup button.
- 3 Use the $\blacktriangle/\blacktriangledown$ buttons to select PLII/NEO:6 CONFIG, then press the Select button.
- 4 Use the $\blacktriangle/\blacktriangledown$ buttons to choose from the following menu items:

PLII MUSIC CONFIG (CENTER WIDTH)

While listening in Dolby Pro Logic IIx Music mode, adjusts the width of the center channel. Use the $\blacktriangle/\blacktriangledown$ buttons to select:

- +0 (narrowest) to +7 (widest)
- The default is 3.

PLII MUSIC CONFIG (DIMENSION)

While listening in Dolby Pro Logic IIx Music mode, adjusts the dimensions of the sound field. Use the $\blacktriangle/\blacktriangledown$ buttons to select:

- -3 (most distant) to +3 (farthest forward)
- The default is 0.

NEO:6 MUSIC CONFIG (CENTER IMAGE)

While listening in Neo:6 Music mode, adjusts the prominence of the center channel to create a wider stereo effect with vocals. Use the $\blacktriangle/\blacktriangledown$ buttons to select:

- +0 (no effect) to +5 (most prominence given to center channel)
- The default is 3.



Note:

- The ProLogic IIx configuration settings apply to both ProLogic II and ProLogic IIx surround modes; see page 57.

Room 2 Basic Configuration

What input source do you want to play in Room 2? Once that is specified, you have the option of fine tuning audio levels depending on the requirements of your Room 2 audio system.

To access the Room 2 Configuration menu:

- 1 Press the Main button on the remote control.
- 2 Press the Setup button.
- 3 Use the \blacktriangle / \blacktriangledown buttons to select ROOM 2 CONFIG, then press the Select button.
 - Note: You can also access the Room 2 Configuration menu by pressing the Room Two Setup button on the GTP-870HD front panel.
- 4 Use the \blacktriangle / \blacktriangledown buttons to choose from the following menu items:

ROOM 2

Enables Room 2 playback. Use the \blacktriangle / \blacktriangledown buttons to select:

- On or Off

MUTE

Mutes Room 2 audio. Use the \blacktriangle / \blacktriangledown buttons to select:

- On or Off
- If the Room 2 setting is Off, you will not be able to set Mute to On.

INPUT

Sets the audio input for Room 2. Use the \blacktriangle / \blacktriangledown buttons to select:

- Video 2, Video 3, Video 4, CD, Tuner AM, or Tuner FM
- When Room 2 is enabled, the selected input source will be sent from the Zone 2 Outputs on the GTP-870HD rear panel to the audio inputs of your Room 2 receiver.

VOLUME

Adjusts the volume level of the Room 2 audio signal. Use the \blacktriangle / \blacktriangledown buttons to set the volume level:

- The available range is -65 dB to 0 dB.
- The default setting is -40 dB.

ADVANCED SETTINGS

See page 42.

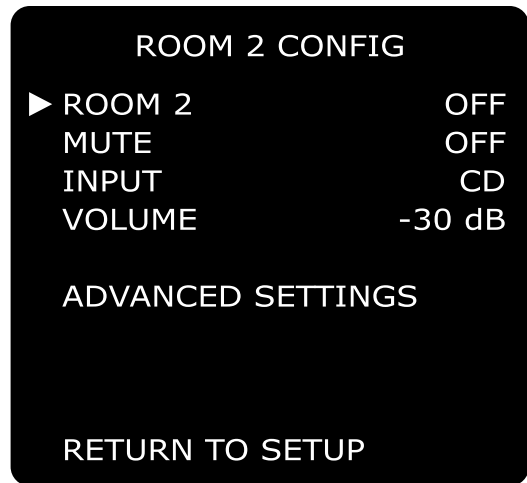

Room 2 Advanced Configuration

The Room 2 Advanced Configuration menu contains powerful tools to customize and optimize the output of the GTP-870HD to your secondary audio system.

To access the Room 2 Advanced Config menu:

- 1 Press the Main button on the remote control.
- 2 Press the Setup button.
- 3 Use the $\blacktriangle/\blacktriangledown$ buttons to select ROOM 2 CONFIG, then press the Select button.
- 4 Use the $\blacktriangle/\blacktriangledown$ buttons to select ADVANCED SETTINGS, then press the Select button.
- 5 Use the $\blacktriangle/\blacktriangledown$ buttons to choose from the following menu items:

SURROUND

Turns a “pseudo” surround effects mode on/off. Use the $\blacktriangle/\blacktriangledown$ buttons to select:

- On or Off

VOCAL CUT

Attenuates the normal “vocal” audio frequency range. Use the $\blacktriangle/\blacktriangledown$ buttons to select:

- On or Off

BALANCE L / BALANCE R

Adjusts the left and right channel balance from the Zone 2 outputs. Use the $\blacktriangle/\blacktriangledown$ buttons to select:

- -8 to +8 dB

TONE

Turns tone control on/off. Selecting On enables the Bass & Treble effects (see below). Use the $\blacktriangle/\blacktriangledown$ buttons to select:

- On or Off

BASS / TREBLE

Adjusts the bass and treble of the audio signal from the Zone 2 outputs. Bass and Treble (Tone control) adjustments are only effective when “TONE” is On (see above). Use the $\blacktriangle/\blacktriangledown$ buttons to select:

- -8 to +8 dB

INITIAL POWER

Sets Room 2 to initialize in either On or Off mode whenever the main rear panel power switch is turned on (1). Use the $\blacktriangle/\blacktriangledown$ buttons to select:

- On or Off

RM2 ADVANCED CONFIG

▶ SURROUND	OFF
VOCAL CUT	OFF
BALANCE L	+0 dB
BALANCE R	+0 dB
TONE	OFF
BASS	+0 dB
TREBLE	+0 dB
INITIAL POWER	OFF
INPUT GAIN CONFIG	
RETURN TO SETUP	

RM2 INPUT GAIN

▶ VIDEO 2	+0 dB
VIDEO 3	+0 dB
VIDEO 4	+0 dB
CD	+0 dB
AM TUNER	+0 dB
FM TUNER	+0 dB
RETURN TO SETUP	

INPUT GAIN CONFIG

Launches the Room 2 Input Gain menu, where you can set the relative gain for each possible Room 2 input source.

- Use the $\blacktriangle/\blacktriangledown$ buttons to select the desired input (Video 2, Video 3, Video 4, CD, AM Tuner, FM Tuner).
- Then use the $\blacktriangle/\blacktriangledown$ buttons to set the input gain from -8 to +6 dB.

System Configuration

The System Configuration menu provides initial power, on-screen display time outs, and system tools to put the finishing touches on your system setup.

One critical tool is the “Setup Lock,” which allows you to lock down all the settings you’ve made to the GTP-870HD to prevent accidental changes or tampering with the unit.

To access the System Configuration menu:

- 1 Press the Main button on the remote control.
- 2 Press the Setup button.
- 3 Use the ▲/▼ buttons to select SYSTEM CONFIG, then press the Select button.
- 4 Use the ▲/▼ buttons to choose from the following menu items:

INITIAL POWER

Sets the GTP-870HD to initialize in either On or Standby mode whenever the main rear panel power switch is turned on (1). Use the ◀/▶ buttons to select:

- On or Off (Standby mode)

OSD TIME OUT

Sets on-screen displays to time out after a specified length of time. Use the ◀/▶ buttons to set the time out duration from:

- 0-30 seconds

SETUP LOCK

Once you have set up your GTP-870HD and are pleased with its operations, you may want to “lock down” your settings to prevent accidental changes. Use the ◀/▶ buttons to select:

- On or Off
- If you select On and exit the Setup menu, the Setup menu will no longer be accessible, even if you press the Setup button.
- To override the Setup lock: Press and hold both the Video 2 button and the Sur Mode button on the front panel at the same time.

VID BLK LVL

The Video Black Level feature adjusts the reference level of black in the video signal. Use the ◀/▶ buttons to select:

- 7.5 IRE - Standard NTSC black level. Yields consistent contrast through all sources.
- 0 IRE - Enhanced black level. For increased contrast during DVD playback.

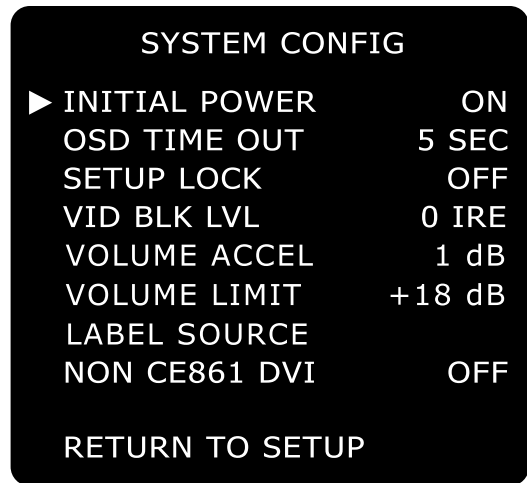

VOLUME ACCEL

Sets the rate of acceleration (the speed at which the volume goes up or down) when you press and hold the Volume +/- buttons on the remote control. Use the ◀/▶ buttons to select:

- 0.5 dB, 1 dB or 2 dB
- The default setting is 1 dB.

VOLUME LIMIT

Sets the maximum volume level for the system. Once set, the master volume cannot exceed this limit unless you change this setting. Use the ◀/▶ buttons to select:

- -10 dB to +18 dB
- The default setting is +18 dB.

LABEL SOURCE

Displays the Label Source menu.

- See page 44.

NON CE861 DVI

Turn this setting on ONLY if you have a ‘legacy’ display device that does not conform to the Consumer Electronics Association specification EIA/CEA 861. Use the ◀/▶ buttons to select:

- On or Off.

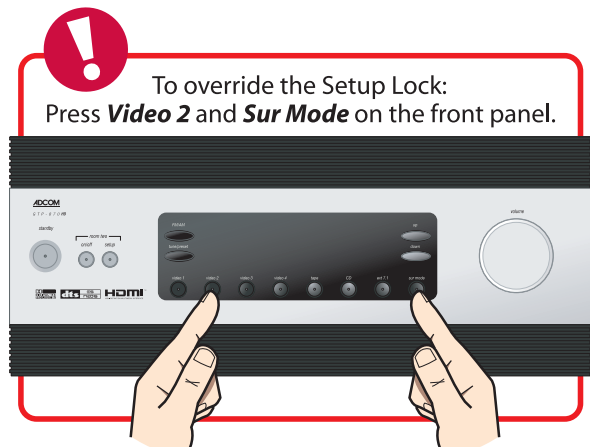

Input Labeling

Tired of trying to remember which source device goes with which Video input? The Label Source menu allows you to label your inputs with names that uniquely identify your source devices.

To access the Label Source menu:

- 1 Press the Main button on the remote control.
- 2 Press the Setup button.
- 3 Use the $\blacktriangle/\blacktriangledown$ buttons to select SYSTEM CONFIG, then press the Select button.
- 4 Use the $\blacktriangle/\blacktriangledown$ buttons to select LABEL SOURCE, then press the Select button.
- 5 Use the $\blacktriangle/\blacktriangledown$ buttons to choose from the following menu items:

INPUT NAME

Displays the current name of the selected source device.

- No settings are necessary.

SOURCE

Selects the input source you want to label. Use the $\blacktriangle/\blacktriangleright$ buttons to select:

- Video 1, Video 2, Video 3, Video 4, CD, Tuner AM, or Tuner FM

EDIT NAME

Displays the Edit Name menu.

- Use the $\blacktriangle/\blacktriangledown/\blacktriangleleft/\blacktriangleright$ buttons to select a character, then press the Select button to add the character to the input name.
- The left and right arrow symbols are used for navigation within the input name.
- The “space” character is located between the left and right arrow symbols.
- Names can be up to 8 characters long.

ERASE NAME

Erases the input name and opens the Edit Name menu (see above).

- If you want the input name to be blank (i.e., no name will be displayed for the selected input), select Erase Name, then select Return to Setup.

LABEL SOURCE

```

INPUT NAME  VIDEO 1
▶ SOURCE    VIDEO 1
EDIT NAME
ERASE NAME
  
```

RETURN

EDIT NAME

```

SOURCE      VIDEO 1
INPUT NAME  VIDEO 1
  
```

```

▶ ABCDEFGHIJ
  KLMNOPQRST
  UVWXYZ!◀ ▶
  0123456789
  
```

RETURN TO SETUP

Analog Input Level

The GTP-870HD allows you to adjust the voltage reference levels independently for each of the unit's seven analog audio inputs. Check the technical specifications of your source components to determine the optimum reference level setting.

To access the Analog Input Level menu:

- 1 Press the Main button on the remote control.
- 2 Press the Setup button.
- 3 Use the $\blacktriangle/\blacktriangledown$ buttons to select ANALOG INPUT LEVEL, then press the Select button.
- 4 Use the $\blacktriangle/\blacktriangledown$ buttons to choose from the following menu items:

CD

Adjusts the analog input level for the CD audio input.

Use the $\blacktriangle/\blacktriangleright$ buttons to select:

- 2 V REF (default)
- 4 V HIGH
- 1 V LOW

VIDEO 1~4

Adjusts the analog input level for the Video 1-4 audio inputs. Use the $\blacktriangle/\blacktriangleright$ buttons to select:

- 2 V REF (default)
- 4 V HIGH
- 1 V LOW

TAPE

Adjusts the analog input level for the Tape input. Use the $\blacktriangle/\blacktriangleright$ buttons to select:

- 2 V REF (default)
- 4 V HIGH
- 1 V LOW

TUNER

Adjusts the analog input level for the Tuner input.

Use the $\blacktriangle/\blacktriangleright$ buttons to select:

- 2 V REF (default)
- 4 V HIGH
- 1 V LOW

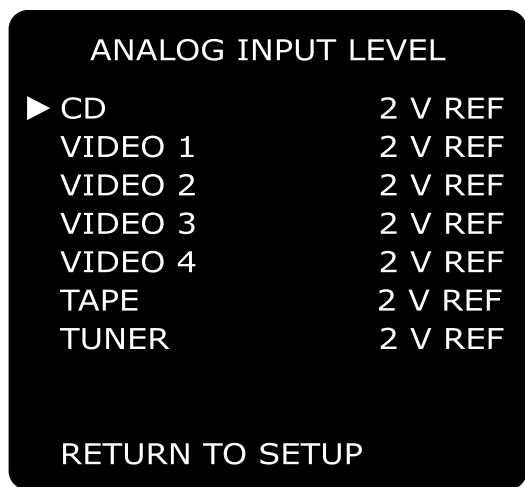

Remote Control Setup

The GTP-870HD is a learning remote control that is capable of storing and executing commands for all remote controls in your home theater system. In this way, you can eliminate the confusion of using multiple remotes.

This section is divided into two main parts:

Using Preprogrammed Commands

The first section is an overview of the preprogrammed commands for each source:

- Main commands 39
- Video 1-3 commands 39
- Video 4 commands (GDV-850) 40
- CD commands (GCD-750) 40
- Tuner commands 41
- Rm 2 commands 41

Note: Main commands are not programmable, except for the four user macros (M1, M2, M3, and M4).

Programming Remote Commands

The second section includes instructions for programming the remote for each source:

- Programming commands 39
- Deleting commands 40
- Deleting all commands for a single component 41
- Deleting all commands for all components 41
- Programming macro buttons 41
- Deleting macro buttons 42
- Discrete remote control commands 42



Pressing a source button on the remote control not only selects the input associated with that source...



...but it also remaps the remote control buttons for that source.

Using Preprogrammed Commands

The following commands are preprogrammed for the Main and Video 1-3 inputs:

Main Commands

Button	Function	Code
main	Selects GTP-870HD codes	-
vid 1	Selects VIDEO 1 codes	131
vid 2	Selects VIDEO 2 codes	132
vid 3	Selects VIDEO 3 codes	133
vid 4	Selects VIDEO 4 codes (GDV-850)	134
CD	Selects CD codes (GCD-750)	136
tuner	Selects GTP-870HD Tuner codes	137
Rm. 2	Selects GTP-870HD Room 2 codes	203
power	Toggles Power On/Standby	128
ext 7.1	Toggles External 7.1 input On/Off	193
tape	Toggles Tape Monitor On/Off	138
mute	Toggles Audio Mute On/Off	130
setup	GTP-870HD OSD Setup Menu	129
volume ▲	Master Volume UP	213
volume ▼	Master Volume DN	209
play	GDV-850 play	113
menu	GTP-870HD OSD Setup Menu	129
▲	OSD Navigation Up	64
▼	OSD Navigation Down	65
◀ / ⏪	OSD Navigation Left	66
▶ / ⏩	OSD Navigation Right	67
select	OSD Select/Enter	3
pause	GDV-850 pause/step	49
stop	GDV-850 stop	50
mode	Steps surround modes	87
th-eq	Toggles theater EQ On/Off	222
ch-trim	Channel balance Adjust menu	199
test	Toggles Noise Gen_Trim Adj. On/Off	80
1	Tuner preset select	144
2	Tuner preset select	145
3	Tuner preset select	146
4	Tuner preset select	147
5	Tuner preset select	148
6	Tuner preset select	149
7	Tuner preset select	150
8	Tuner preset select	151
9	Tuner preset select	152
+10	Tuner preset select (+10 adder)	153
tune +	Tune UP (step)	140
tune -	Tune DOWN (step)	141
FM/AM/HD	Toggles FM/AM/HD tuner	143
mem	saves a preset	11
Pre/Tune	Toggles Presets/Tuner	211
St/Mon	Toggles Stereo/Monaural	221
seek	Seek (UP) next Preset/Station	208
bass	Displays Bass adjust menu	79
treble	Displays Treble adjust menu	207
bypass	Toggles tone bypass On/Off	77
d.range	Toggles Night Mode: 100/75/50/25	223
sync	Toggles Lip sync Adj.	212
m1	User macro	-
m2	User macro	-
m3	User macro	-
m4	User macro	-
sleep	Set sleep (off, 30, 60, 90) step	198
dim	VFD (Off, Dim, Bright) step	202
backlight	illuminate remote control	-

Video 1-3 Commands

Button	Function	Code
main	Selects GTP-870HD codes	-
vid 1	Selects VIDEO 1 codes	131
vid 2	Selects VIDEO 2 codes	132
vid 3	Selects VIDEO 3 codes	133
vid 4	Selects VIDEO 4 codes (GDV-850)	134
CD	Selects CD codes (GCD-750)	136
tuner	Selects GTP-870HD Tuner codes	137
Rm. 2	Selects GTP-870HD Room 2 codes	203
power	Toggles Power On/Standby	128
ext 7.1	Toggles External 7.1 input On/Off	193
tape	Toggles Tape Monitor On/Off	138
mute	Toggles Audio Mute On/Off	130
setup	Programmable	-
volume ▲	Master Volume UP	213
volume ▼	Master Volume DN	209
play	Programmable	-
menu	Programmable	-
▲	Programmable	-
▼	Programmable	-
◀ / ⏪	Programmable	-
▶ / ⏩	Programmable	-
select	Programmable	-
pause	Programmable	-
stop	Programmable	-
mode	Steps surround modes	87
th-eq	Toggles theater EQ On/Off	222
ch-trim	Channel balance Adjust menu	199
test	Toggles Noise Gen_Trim Adj. On/Off	80
1	Programmable	-
2	Programmable	-
3	Programmable	-
4	Programmable	-
5	Programmable	-
6	Programmable	-
7	Programmable	-
8	Programmable	-
9	Programmable	-
+10	Programmable	-
tune +	Programmable	-
tune -	Programmable	-
FM/AM/HD	Programmable	-
mem	Programmable	-
Pre/Tune	Programmable	-
St/Mon	Programmable	-
seek	Programmable	-
bass	Displays Bass adjust menu	79
treble	Displays Treble adjust menu	207
bypass	Toggles tone bypass On/Off	77
d.range	Toggles Night Mode: 100/75/50/25	223
sync	Toggles Lip sync Adj.	212
m1	User macro	-
m2	User macro	-
m3	User macro	-
m4	User macro	-
sleep	Set sleep (off, 30, 60, 90) step	198
dim	VFD (Off, Dim, Bright) step	202
backlight	illuminate remote control	-

Using Preprogrammed Commands

The following commands are preprogrammed for the Video 4 and CD inputs:

Video 4 (GDV-850) Commands

Button	Function	Code
main	Selects GFR-700HD codes	-
vid 1	Selects VIDEO 1 codes	131
vid 2	Selects VIDEO 2 codes	132
vid 3	Selects VIDEO 3 codes	133
vid 4	Selects VIDEO 4 codes (GDV-850)	134
CD	Selects CD codes (GCD-750)	136
tuner	Selects GFR-700HD Tuner codes	137
Rm. 2	Selects GFR-700HD Room 2 codes	203
power	GDV-850 Power On/Off	101
ext 7.1	Toggles External 7.1 input On/Off	193
tape	Toggles Tape Monitor On/Off	138
mute	Toggles Audio Mute On/Off	130
setup	GDV-850 Setup Menu	33
volume ▲	Master Volume UP	213
volume ▼	Master Volume DN	209
play	GDV-850 play	113
menu	GDV-850 Disc Menu	99
▲	GDV-850 Navigation Up	100
▼	GDV-850 Navigation Down	61
◀ / ⏪	GDV-850 Navigation Left	60
▶ / ⏩	GDV-850 Navigation Right	104
select	GDV-850 Select/Enter	113
pause	GDV-850 pause/step	49
stop	GDV-850 stop	50
mode	Steps surround modes	87
th-eq	Toggles theater EQ On/Off	222
ch-trim	GDV-850 Display Key	114
test	GDV-850 Audio Key	98
1	GDV-850 Key 1	36
2	GDV-850 Key 2	37
3	GDV-850 Key 3	127
4	GDV-850 Key 4	39
5	GDV-850 Key 5	40
6	GDV-850 Key 6	41
7	GDV-850 Key 7	42
8	GDV-850 Key 8	43
9	GDV-850 Key 9	44
+10	GDV-850 Key 10+	45
tune +	GDV-850 Fast Forward	52
tune -	GDV-850 Fast Reverse	124
FM/AM/HD	Programmable	-
mem	Programmable	-
Pre/Tune	Programmable	-
St/Mon	Programmable	-
seek	GDV-850 Goto Key	116
bass	Toggles Bass adjust menu	79
treble	Toggles Treble adjust menu	207
bypass	Toggles tone bypass On/Off	77
d.range	Toggles Night Mode: 100/75/50/25	223
sync	Toggles Lip sync Adj.	212
m1	User macro	-
m2	User macro	-
m3	User macro	-
m4	User macro	-
sleep	Auto Off step (off, 30, 60, 90)	198
dim	VFD step (Off, Dim, Bright)	202
backlight	illuminate remote control	-

CD (GCD-750) Commands

Button	Function	Code
main	Selects GFR-700HD codes	-
vid 1	Selects VIDEO 1 codes	131
vid 2	Selects VIDEO 2 codes	132
vid 3	Selects VIDEO 3 codes	133
vid 4	Selects VIDEO 4 codes (GDV-850)	134
CD	Selects CD codes (GCD-750)	136
tuner	Selects GFR-700HD Tuner codes	137
Rm. 2	Selects GFR-700HD Room 2 codes	203
power	GCD-750 Power	6
ext 7.1	Toggles External 7.1 input On/Off	193
tape	Toggles Tape Monitor On/Off	138
mute	Toggles Audio Mute On/Off	130
setup	Programmable	-
volume ▲	Master Volume UP	213
volume ▼	Master Volume DN	209
play	GCD-750 play	5
menu	GCD-750 Open/Close	15
▲	Programmable	-
▼	Programmable	-
◀ / ⏪	GCD-750 Fast Forward	0
▶ / ⏩	GCD-750 Fast Reverse	1
select	GCD-750 play	5
pause	GCD-750 pause	14
stop	GCD-750 stop	4
mode	Steps surround modes	87
th-eq	Toggles theater EQ On/Off	222
ch-trim	Channel balance Adjust menu	199
test	Toggles Noise Gen_Trim Adj. On/Off	80
1	GCD-750 1	16
2	GCD-750 2	17
3	GCD-750 3	18
4	GCD-750 4	19
5	GCD-750 5	20
6	GCD-750 6	21
7	GCD-750 7	22
8	GCD-750 8	23
9	GCD-750 9	24
+10	GCD-750 10+	25
tune +	GCD-750 Forward	13
tune -	GCD-750 Reverse	12
FM/AM/HD	Programmable	-
mem	Programmable	-
Pre/Tune	GCD-750 Repeat	73
St/Mon	GCD-750 Random	78
seek	GCD-750 Scan	70
bass	Toggles Bass adjust menu	79
treble	Toggles Treble adjust menu	207
bypass	Toggles tone bypass On/Off	77
d.range	Toggles Night Mode: 100/75/50/25	223
sync	GCD-750 Digital Input	68
m1	User macro	-
m2	User macro	-
m3	User macro	-
m4	User macro	-
sleep	Auto Off step (off, 30, 60, 90)	198
dim	GCD-750 Light	71
backlight	illuminate remote control	-

Using Preprogrammed Commands

The following commands are preprogrammed for the Tuner and Room 2 inputs:

Tuner Commands

Button	Function	Code
main	Selects GTP-870HD codes	-
vid 1	Selects VIDEO 1 codes	131
vid 2	Selects VIDEO 2 codes	132
vid 3	Selects VIDEO 3 codes	133
vid 4	Selects VIDEO 4 codes (GDV-850)	134
CD	Selects CD codes (GCD-750)	136
tuner	Selects GTP-870HD Tuner codes	137
Rm. 2	Selects GTP-870HD Room 2 codes	203
power	Toggles Power On/Standby	128
ext 7.1	Programmable	-
tape	Toggles Tape Monitor On/Off	138
mute	Toggles Audio Mute On/Off	130
setup	GTP-870HD OSD Setup Menu	129
volume ▲	Master Volume UP	213
volume ▼	Master Volume DN	209
play	Programmable	-
menu	GTP-870HD OSD Setup Menu	129
▲	OSD Navigation Up	64
▼	OSD Navigation Down	65
◀ / ⏪	OSD Navigation Left	66
▶ / ⏩	OSD Navigation Right	67
select	OSD Select/Enter	3
pause	Programmable	-
stop	Programmable	-
mode	Steps surround modes	87
th-eq	Toggles theater EQ On/Off	222
ch-trim	Channel balance Adjust menu	199
test	Toggles Noise Gen_Trim Adj. On/Off	80
1	Tuner preset select	144
2	Tuner preset select	145
3	Tuner preset select	146
4	Tuner preset select	147
5	Tuner preset select	148
6	Tuner preset select	149
7	Tuner preset select	150
8	Tuner preset select	151
9	Tuner preset select	152
+10	Tuner preset select (+10 adder)	153
tune +	Tune UP (step)	140
tune -	Tune DOWN (step)	141
FM/AM/HD	Toggles FM/AM/HD tuner	143
mem	Saves a preset	11
Pre/Tune	Toggles Presets/Tuner	211
St/Mon	Toggles Stereo/Monaural	221
seek	Seek (UP) next Preset/Station	208
bass	Displays Bass adjust menu	79
treble	Displays Treble adjust menu	207
bypass	Toggles tone bypass On/Off	77
d.range	Toggles Night Mode: 100/75/50/25	223
sync	Programmable	-
m1	User macro	-
m2	User macro	-
m3	User macro	-
m4	User macro	-
sleep	Set sleep (off, 30, 60, 90) step	198
dim	VFD (Off, Dim, Bright) step	202
backlight	illuminate remote control	-

Room 2 Commands

Button	Function	Code
main	Selects GTP-870HD codes	N/A
vid 1	Selects VIDEO 1 codes	131
vid 2	Selects VIDEO 2 codes	132
vid 3	Selects VIDEO 3 codes	133
vid 4	Selects VIDEO 4 codes (GDV-850)	134
CD	Selects CD codes (GCD-750)	136
tuner	Selects GTP-870HD Tuner codes	137
Rm. 2	Selects GTP-870HD Room 2 codes	203
power	Room 2 Power On/Off	74
ext 7.1	Programmable	-
tape	Programmable	-
mute	Room 2 Audio Mute On/Off	81
setup	Room 2 OSD Menu On/Off	75
volume ▲	Room 2 Volume UP	85
volume ▼	Room 2 Volume DN	86
play	Programmable	-
menu	Room 2 OSD Menu On/Off	75
▲	OSD Navigation Up	64
▼	OSD Navigation Down	65
◀ / ⏪	OSD Navigation Left	66
▶ / ⏩	OSD Navigation Right	67
select	OSD Select/Enter	3
pause	Programmable	-
stop	Programmable	-
mode	Programmable	-
th-eq	Programmable	-
ch-trim	Programmable	-
test	Programmable	-
1	Programmable	-
2	Programmable	-
3	Programmable	-
4	Programmable	-
5	Programmable	-
6	Programmable	-
7	Programmable	-
8	Programmable	-
9	Programmable	-
+10	Programmable	-
tune +	Programmable	-
tune -	Programmable	-
FM/AM/HD	Programmable	-
mem	Programmable	-
Pre/Tune	Programmable	-
St/Mon	Programmable	-
seek	Programmable	-
bass	Programmable	-
treble	Programmable	-
bypass	Programmable	-
d.range	Programmable	-
sync	Programmable	-
m1	User macro	-
m2	User macro	-
m3	User macro	-
m4	User macro	-
sleep	Programmable	-
dim	Programmable	-
backlight	illuminate remote control	-

Programming Remote Commands

Once you're familiar with the preprogrammed commands, you may wish to program specific buttons on the GTP-870HD remote to control your source components. To do this, you will need:

- Your source component remote control, which will teach the new command.
- The GTP-870HD remote control, which will learn the new command.

Programming a Command

- 1 Place your source remote "head-to-head" with the GTP-870HD remote.
 - The two remotes should be in line with each other, about 2 to 3 inches apart.
- 2 On the GTP-870HD remote, press the applicable Source and Select buttons simultaneously.
 - The orange status LED and the Source button glow and remain lit.
- 3 On the GTP-870HD remote, press the button to be taught.
 - The orange status LED begins flashing.
- 4 On the Source remote control, press and hold the button to be copied.
 - The green status LED glows and remains lit.
- 5 Release the button on the Source remote control.
 - The orange status LED begins flashing again.
- 6 Press the button on the Source remote control a second time.
 - The green status LED blinks twice and then goes back to steady orange to indicate that the command has been saved.
 - Repeat steps 4-6 for any other commands you want to teach your GTP-870HD remote for that Source component.
- 7 Press the Source and Select buttons simultaneously to save.
 - The orange status LED blinks twice and turns off.

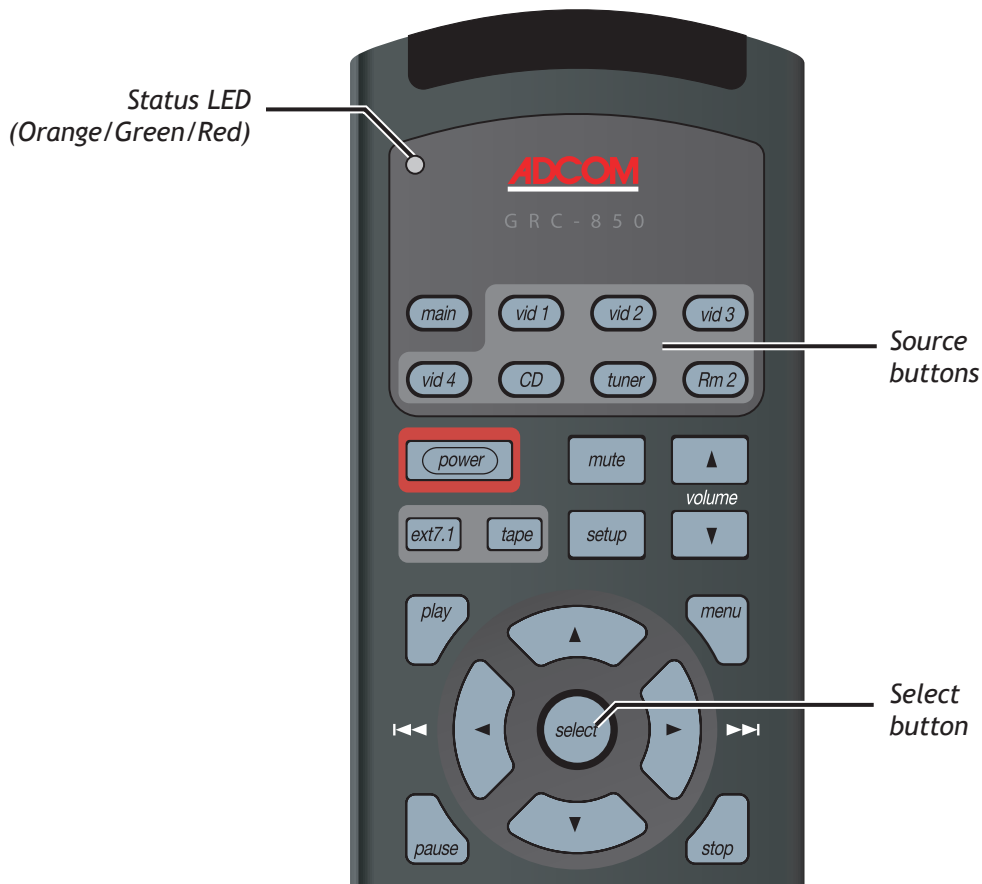

Deleting Remote Commands

Deleting a Command

- 1 On the GTP-870HD remote, press the applicable Source and Select buttons simultaneously.
 - The orange status LED and the Source button glow and remain lit.
- 2 Press the button whose function you wish to clear.
 - The orange status LED begins flashing.
- 3 Press the Backlight button.
 - The green status LED blinks twice and then goes back to steady orange to indicate that the command has been deleted.
 - Repeat steps 2-3 for any other commands you wish to delete for that Source component.
- 4 Press the Source and Select buttons simultaneously to save and exit.
 - The orange status LED blinks twice and turns off.

Deleting all Commands for a Component

- 1 On the GTP-870HD remote, press the Source and Select buttons simultaneously.
 - The orange status LED and the Source button glow and remain lit.

- 2 Press and hold the Backlight button.
 - The red status LED blinks five times.
 - The green status LED then blinks twice and goes back to steady orange to indicate that all commands for the selected Source component have been deleted.
- 3 Press the Source and Select buttons simultaneously to save and exit.
 - The status LED blinks twice and turns off.

Deleting all Commands for all Components

This procedure erases every programmed command accessed under the selected Video 1, Video 2, Video 3, Video 4, CD, Tuner, and Room 2 input selectors. Make sure you really want to do this before following the step below.

- 1 Press and hold the Video 2 button and the Backlight button simultaneously.
 - The red status LED blinks twelve times.
 - The status LED will then flash green once, followed by a single orange pulse.
- 2 All LEDs will then turn off, indicating that every learned command in the GTP-870HD remote has been erased.



Backlight button

Programming Macro Buttons

If you find yourself repeatedly pressing the same sequence of buttons while using your GTP-870HD, then consider taking advantage of the built-in Macro feature. Macros allow you to execute a series of commands (up to ten button presses) at the touch of a single button.

Each Macro button (labeled M1, M2, M3, and M4) can store two macros, one for each “group” of input buttons:

- **Group 1 inputs** - Main, Video 1, Video 2, and Video 3
- **Group 2 inputs** - Video 4, CD, Tuner, Room 2

For example, if you program the M1 macro in Group 1, the macro will perform the same series of steps whether you are in any Group 1 mode (Main, Video 1, Video 2, or Video 3).

Programming a Macro Button

- 1 Press a Source button (Main or Vid 4) and the Ext7.1 button, simultaneously.
 - Hold both buttons until the red light under the Source button turns on.
- 2 Press one of the five macro buttons (M1-M4, Power) you wish to program.
 - The red light under the Source button will blink once for each subsequent button press.
- 3 Press up to 10 commands you would like to include in the macro sequence.
 - Pressing a Source button to change modes is counted as one command.

Note:

- *The Power On/Off command, for devices other than the Main receiver, is programmed into a macro using the Ext7.1 button.*
- 4 Press the Volume ▲ button to store the commands.
 - The red Status LED and the Source button will blink twice to confirm the program and then turn off.

Deleting a Macro button

- 1 Press the Source button (Main or Vid 4) and the Ext7.1 button, simultaneously.
 - Hold both buttons until the red light under the Source button turns on.
- 2 Press the macro button (M1-M4, Power) you wish to delete.
 - The red light under the Source button will blink once.
- 3 Press the Volume ▲ button to delete the macro.
 - The red Status LED and the Source button will blink twice to confirm deletion and then turn off.

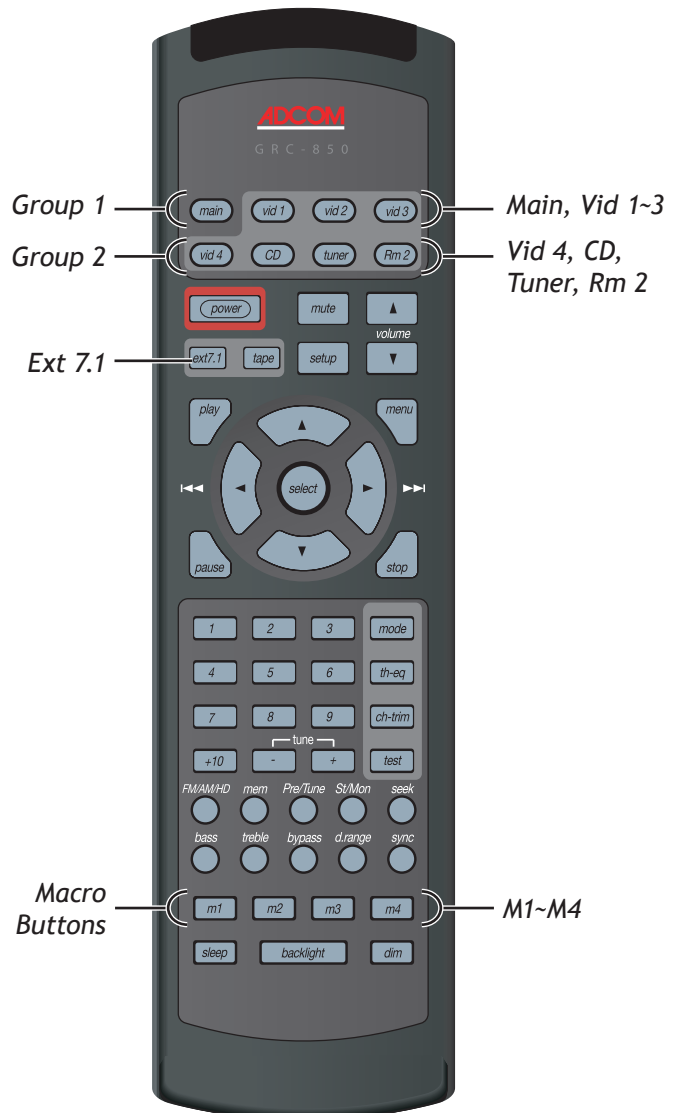

Discrete Remote Control Commands

The GTP-870HD can be controlled via its serial RS-232 port. The serial port can be connected to a media control center, PC, or 'dumb terminal' via a straight-through standard 9-pin serial port cable (MALE on one end and FEMALE on the other end). When using a PC, a terminal emulator program (e.g. HyperTerminal), can be used to control the GTP-870HD. The communications parameters should be set as follows:

- 9600 baud, 8 data bits, no parity, 1 stop bit, and Flow Control: Hardware.
- All serial port control commands are structured as a four byte packet or string "<SOP>, <cmd>, <data>, <EOP>".
- SPECIAL RESERVED CHARACTERS: <SOP> Start Of Packet = 0x7B = "{" (The Left Curly Bracket); <EOP> End Of Packet = 0x7D = "}" (The Right Curly Bracket).
- Example syntax for the Discrete Remote Control Command for 'Main Volume UP' expressed as a hexadecimal string: 0x7B, 0x44, 0x2B, 0x7D

Function Description	Data	ASCII
Main Volume UP	0x2B	+
Main Volume DOWN	0x2D	-
Main Mute	0x5B	[
Main Un-mute	0x5D]
Sleep OFF	0x1F	US
Sleep (30)	0x20	SPACE
Sleep (60)	0x21	!
Sleep (90)	0x22	"
Sleep (120)	0x0A	LF
Sleep (180)	0x12	DC2
Test tone (noise) On	0x28	(
Test tone (noise) Off	0x29)
VFD (Bright)	0x5C	\
VFD (Dim)	0x2C	,
VFD (OFF)	0x23	#
Dynamic Range Normal (100%)	0x25	%
Dynamic Range 75%	0x40	@
Dynamic Range 50%	0x3F	?
Dynamic Range 25%	0x2F	/
Surround Mode select: (steps through available modes)	0x30	0
Direct SurMode select: DOLBY DIGITAL	0x38	8
Direct SurMode select: DOLBY PRO LOGIC	0x31	1
Direct SurMode select: DOLBY PLII-CINEMA	0x53	S
Direct SurMode select: DOLBY PLII-MUSIC	0x2E	.
Direct SurMode select: DOLBY PLII-PANORAMA	0x54	T
Direct SurMode select: DOLBY DIGITAL EX	0x32	2
Direct SurMode select: DOLBY PLIIX-CINEMA	0x0E	SO
Direct SurMode select: DOLBY PLIIX-MUSIC	0x0F	SI

Function Description	Data	ASCII
Direct SurMode select: DOLBY PLIIX-PANORAMA	0x10	DLE
Direct SurMode select: DTS	0x34	4
Direct SurMode select: DTS NEO:6-CINEMA	0x51	Q
Direct SurMode select: DTS NEO:6-MUSIC	0x52	R
Direct SurMode select: DTS-ES	0x39	9
Direct SurMode select: ADCOM 7.1m2 STEREO	0x33	3
Direct SurMode select: 5 CHANNEL STEREO	0x36	6
Direct SurMode select: 2 CHANNEL STEREO	0x37	7
Direct SurMode select: HALL	0x35	5
OSD Setup Menu (Toggle On/Off)	0x11	DC1
OSD Navigation Up	0x5E	^
OSD Navigation Down	0x5F	_
OSD Navigation Select / Enter	0x3D	=
OSD Navigation Left	0x3C	<
OSD Navigation Right	0x3E	>
Front Left Channel Trim +	0x55	U
Front Left Channel Trim -	0x56	V
Front Right Channel Trim +	0x57	W
Front Right Channel Trim -	0x58	X
Surround Left Channel Trim +	0x41	A
Surround Left Channel Trim -	0x42	B
Surround Right Channel Trim +	0x43	C
Surround Right Channel Trim -	0x44	D
Surround Back Left Channel Trim +	0x45	E
Surround Back Left Channel Trim -	0x46	F
Surround Back Right Channel Trim +	0x47	G
Surround Back Right Channel Trim -	0x48	H
Center Channel Trim +	0x49	I
Center Channel Trim -	0x4A	J
Subwoofer Channel Trim +	0x4B	K

Function Description	Data	ASCII
Subwoofer Channel Trim -	0x4C	L
Lip Sync Adjust Down (Decrease delay)	0x0D	CR
Lip Sync Adjust Up (Increase delay)	0x60	`
Theater EQ compensation - ON	0x69	i
Theater EQ compensation - OFF	0x6A	j
Select: "tape" Monitor (Toggle On/Off)	0x71	q
Select: "ext 7.1 inputs" - On	0x26	&
Select: "ext 7.1 inputs" - Off	0x2A	*
Select Analog "audio" input (for Current Source)	0x59	Y
Select Digital "coaxial 1" input (for Current Source)	0x5A	Z
Select Digital "coaxial 2" input (for Current Source)	0x3A	:
Select Digital "coaxial 3" input (for Current Source)	0x3B	;
Select Digital "optical 1" input (for Current Source)	0x05	ENQ
Select Digital "optical 2" input (for Current Source)	0x24	\$
Select Digital "optical 3" input (for Current Source)	0x27	'
Select Source: VIDEO 1	0x6B	k
Select Source: VIDEO 2	0x6C	l
Select Source: VIDEO 3	0x6D	m
Select Source: VIDEO 4	0x6E	n
Select Source: CD	0x70	p
Select Source: TUNER (AM)	0x6F	o
Select Source: TUNER (FM)	0x72	r
TUNER Scan +	0x61	a
TUNER Scan -	0x62	b
TUNER STEP +	0x63	c
TUNER STEP -	0x64	d
FM mode - MONO	0x65	e
FM mode - STEREO	0x66	f

Function Description	Data	ASCII
TUNER mode - PRESET	0x67	e
TUNER mode - TUNE	0x68	h
TUNER MEMORY Function (Select/Save)	0x73	s
TUNER Preset 1 Select	0x74	t
TUNER Preset 2 Select	0x75	u
TUNER Preset 3 Select	0x76	v
TUNER Preset 4 Select	0x77	w
TUNER Preset 5 Select	0x78	x
TUNER Preset 6 Select	0x79	y
TUNER Preset 7 Select	0x7A	z
TUNER Preset 8 Select	0x7C	
TUNER Preset 9 Select	0x7E	~
TUNER Preset 10+ Select (access 11-32)	0x7F	
Tone EQ Control - On	0x0C	FF
Tone EQ Control - Off	0x13	DC3
Tone EQ Control - Toggle On/Off	0x15	NAK
Tone Reset (Set Bass & Treble = 0dB)	0x14	DC4
Bass EQ Adjust	0x16	SYN
Treble EQ Adjust	0x17	ETB
Room 2 Volume UP (when RM2 is active)	0x01	SQH
Room 2 Volume DOWN (when RM2 is active)	0x02	STX
Room 2 Mute (when RM2 is active)	0x03	ETX
Room 2 Un-mute (when room 2 is active)	0x04	EOT
Selects Input: VID 2 for Room 2 (when RM2 is active)	0x06	ACK
Selects Input: VID 3 for Room 2 (when RM2 is active)	0x07	BELL
Selects Input: VID 4 for Room 2 (when RM2 is active)	0x08	BS
Selects Input: CD for Room 2 (when RM2 is active)	0x09	HT
Selects TUNER for Room 2 (when RM2 is active)	0x0B	VT

Chapter 4 - Operations

Operations Overview

Now that you've connected and configured your GTP-870HD, it's time for the fun part—enjoying the full power and performance of your Adcom system. This chapter covers:

- Basic Audio/Video Playback 56
- Ext. 7.1 Playback 56
- Tape Playback 56
- Selecting Surround Modes 57
- Tone Control 58
- Basic Recording 59
- Tuner Operations 60
- System Operations 61
- Room 2 Operations 62



Basic Audio/Video Playback

Follow these steps to play an audio/video source component connected to the Video 1, Video 2, Video 3, Video 4, or CD inputs.

Playing an AV Source Component

- Before you begin:
 - Power on the GTP-870HD.
 - Power on your source component.
 - Power on your TV/display (if applicable).
 - Power on your amp/subwoofer (if applicable)
- Select your input source.
 - Press the desired Source selector button (Video 1, Video 2, Video 3, Video 4, or CD) on the GTP-870HD.
- Play your Source component.
 - If you programmed the GTP-870HD remote control, press the Play button to initiate playback on your Source component.
 - The output signal from your Source component will be heard through your speaker system and/or seen on your display device.
- Adjust the volume.
 - Turn the Volume knob to adjust the volume from -80dB to 18dB.

Special Playback Features

During playback, choose from these special playback features:

- Mute** - Press the Mute button to temporarily mute the audio.
- Surround modes** - Press the Mode button to override the default Surround mode and choose one of the many built-in options to suit your source material; see page 57.
- Theater EQ** - Press the TH-EQ button to enable Theater EQ sound.
- Dynamic Range** - Press the D. Range button to compress the dynamic range of your audio output (aka, "night mode").
- Sync** - Press the Sync button and use the ◀/▶ buttons to delay the audio if the sound is out of sync with the picture. Press Sync again to toggle lip sync delay on and off.

Picture Format

During playback, press the Select button and use the ◀/▶ buttons to set the picture format to one of the following:

- Auto** - Automatically selects the best picture format for the current output resolution.
- Full** - Stretches a standard 4:3 image to fill a widescreen (16:9) display.

- Zoom** - Zooms the on-screen image proportionally, preserving the original aspect ratio but cropping the picture.
- Squeeze** - Compresses a widescreen image to a 4:3 display.
- NLS (Non-linear Stretch)** - Stretches a 4:3 image to 16:9, but preserves the correct aspect ratio in the center of the picture.

External 7.1 Playback

If your source component is connected to the Ext 7.1 jacks, simply press the Ext 7.1 button on the remote control or front panel.

- To connect a source component to the Ext 7.1 inputs (usually a DVD, DVD-Audio, or SACD player), see page 20.

Tape Playback

If your source component is connected to the Tape input, press the Tape button on the remote control or front panel.

- To connect a source component to the Tape inputs, see page 21.

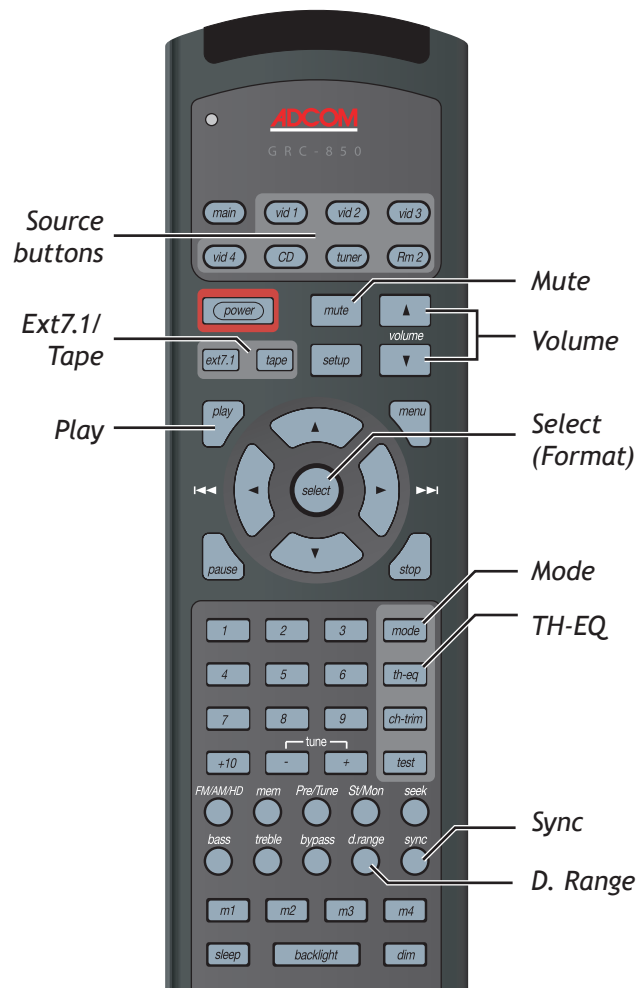

Selecting Surround Modes

If source components are the main course in your home entertainment center, then Surround modes provide the special sauce. Surround modes process incoming audio signals and distribute them to your speakers—with each mode configured to bring out the unique flavor of your source material and send just the right mix to suit your personal taste and specific speaker configuration.

- To set the default Surround mode for each input, see page 33.
- To select Surround modes on the fly, press the Mode button on the remote control or the Sur Mode button on the front panel.

Dolby Surround Modes

DOLBY-D

Decodes the Dolby Digital 5.1-channel bitstreams found on most commercial DVDs, as well as some HDTV and digital cable/satellite programs. Use if:



- Your source component is connected to the GTP-870HD's coaxial or optical digital audio inputs.
- Your source audio is in Dolby Digital 5.1 format.
- You have five speakers plus a subwoofer.

DOLBY-D EX

Decodes the Dolby Digital EX 7.1-channel digital bitstreams found on newer commercial DVDs. Use if:

- Your source component is connected to the GTP-870HD's coaxial or optical digital audio inputs.
- Your source audio is in Dolby Digital EX format.
- You have seven speakers plus a subwoofer.

DOLBY PL

Uses Dolby Pro Logic decoding to expand incoming stereo signals to 4-channel surround sound, where the surround channel is the same for both surround speakers. Use if:

- Your source component is connected to the analog or digital audio inputs.
- Your source audio is in 2-channel analog or digital PCM format.
- You have five speakers (LF, RF, C, LS, RS).

PLII-C, PLII-M, PLII-P

Uses Dolby Pro Logic II decoding to expand incoming stereo signals to 5-channel surround sound, where the surround channel is discrete for both surround speakers. Choose "C" for cinema, "M" for music, or "P" for playing video games. Use if:

- Your source component is connected to the analog or digital audio inputs.
- Your source audio is in 2-channel analog or digital PCM format.
- You have five speakers (LF, RF, C, LS, RS).

PLIIX-C, PLIIX-M, PLIIX-P

Uses Dolby Pro Logic IIx decoding to expand incoming stereo signals to 6.1- or 7.1-channel surround sound. Choose "C" for cinema, "M" for music, or "P" for playing video games. Use if:

- Your source component is connected to the analog or digital audio inputs.
- Your source audio is in 2-channel analog or digital PCM format.
- You have six or seven speakers plus a subwoofer.

DTS Surround Modes

DTS

Decodes the DTS 6-channel digital bitstreams found on many commercial DVDs. Use if:



- Your source component is connected to the GTP-870HD's coaxial or optical digital audio inputs.
- Your source audio is in DTS format.
- You have five speakers plus a subwoofer.

DTS-ES

Decodes the DTS-ES 8-channel digital bitstreams found on newer commercial DVDs. Use if:

- Your source component is connected to the GTP-870HD's coaxial or optical digital audio inputs.
- Your source audio is in DTS-ES format.
- You have seven speakers plus a subwoofer.

NEO:6 C, NEO:6 M

Uses DTS Neo:6 decoding to expand incoming stereo signals from movie or music sources (e.g., VHS tapes, CDs or video games) to 6-channel surround sound. Choose "C" for cinema, or "M" for music. Use if:

- Your source component is connected to the analog or digital audio inputs.
- Your source audio is in 2-channel analog or digital PCM format.
- You have five speakers plus a subwoofer.

Other Surround Modes

7.1 m²

Uses an Adcom-proprietary digital processing technology to expand incoming stereo signals to 7.1-channel surround sound. Use if:



- Your source component is connected to the analog or digital audio inputs.
- Your source audio is in 2-channel analog or digital PCM format.
- You have seven speakers plus a subwoofer.

STEREO

Passes an incoming or downmixed stereo signal to the front speakers. Use if:

- Your source component is connected to an analog or digital audio input.
- Your source audio is in 2-channel analog or digital PCM format.
- You have at least two speakers (LF/RF), or would simply prefer to listen to a multi-channel source through your two front speakers.

HALL

Creates a hall or amphitheater effect from an incoming or downmixed stereo signal. Use if:

- Your source component is connected to an analog or digital audio input.
- Your source audio is in 2-channel analog or digital PCM format.
- You have at least two speakers (LF/RF), or would simply prefer to listen to a multi-channel source through your two front speakers.

5-STEREO

Generates maximum output for a five speaker system. The rear speakers are driven with the same signal as the front left and right, while the center speaker is a monophonic summation of the front speakers. Use if:

- Your source component is connected to an analog or digital audio input.
- Your source audio is in 2-channel analog or digital PCM format.
- You have at least five speakers (LF/RF, C, LS/RS).

Tone Control

Manual Bass/Treble Control

Follow these steps to make Bass/Treble adjustments on the fly:

- Press the Bypass button on the remote control to toggle Tone Control on.
- Use the Bass and Treble buttons to bring up the tone adjustment on-screen display.
- Use the ◀ / ▶ buttons to set the desired level.

Notes:

- *The tone adjustment on-screen display times out after 3 seconds if no button is pressed.*
- *Tone controls are not available in the Dolby Digital EX, DTS-ES, NEO6, and Pro Logic IIx Surround modes.*

Basic Recording

Follow these steps make a recording using the playback and recording components connected to the GTP-870HD. You will first need to identify your Source and Target components.

- Source - This can be the AM/FM tuner or any connected audio/video device (e.g, a cable box, DVD player, VCR, etc.).
- Target - This can be any connected recording device (e.g., a VCR, DVD recorder, PVR, tape recorder, etc.).

Making an Audio/Video Recording

- 1 Before you begin:
 - Power on the GTP-870HD.
 - Power on your Source component.
 - Power on your Target component.
 - Power on your TV/display (if applicable).
 - Power on your amp/subwoofer (if applicable).
- 2 Select your Source device.
 - Press the desired Source selector button (Tuner, Video 1-Video 4 or CD) on the GTP-870HD.

- 3 Cue your Source device.
 - Tune to the desired radio or TV station, or insert and cue up the media (video, CD, DVD, PVR, etc.) you wish to record.
- 4 Cue your Target device.
 - Insert and cue up the recordable media (blank tape, CD-R/RW, DVD-R/RW, etc.) you wish to record to.
- 5 Start recording.
 - Start recording on your Target component, then start playback on your Source component.
 - The output signal from your Source component will be heard through your speaker system and/or seen on your display device.

Notes:

- *You can record using composite and S-video connections interchangeably, but you won't be able to record sources connected to the Component video inputs.*
- *Some audio/video sources are copy-protected, and cannot be recorded.*

Tuner Operations

Follow these steps to use the GTP-870HD's built-in AM/FM tuner. Before you begin, make sure the AM/FM antennas are properly connected; see page 14.

Selecting Tuner Mode

To select Tuner mode:

- Press the Tuner button on the remote control.
- or
- Press the FM/AM button on the front panel.

Selecting the Tuner Band

To switch between the AM/FM bands:

- Press the FM/AM/HD button on the remote control.
- or
- Press the FM/AM button on the front panel.

Switching between Manual and Preset tuning

Manual tuning is used to tune stations and store presets. Preset Tuning is used to select and scan preset stations. To switch between manual and preset tuning:

- Press the Pre/Tune button on the remote control.
- or
- Press the Tuner/Preset button on the front panel.

Tuning Stations Manually

To manually tune stations:

- Press the Tune +/- buttons on the remote control.
 - The AM tuner steps in 10KHz increments.
 - The FM tuner steps in .05MHz increments.

Tuning Stations Automatically

To automatically scan for stations:

- Press the Seek button on the remote control.
- or
- Press the Up/Down buttons on the front panel.

Storing Stations as Presets

The GTP-870HD allows you to store up to 64 presets (32 for each band). To store the selected station as a preset:

- 1 Press the Mem button on the remote control.
- 2 Assign a preset number.
 - Pressing the Mem button automatically assigns the selected station to the next available preset number.
 - To assign the preset to a different number, use the Tune +/- buttons to select the desired preset number, and then press the Mem button to save.

Selecting Preset Stations

To select preset stations:

- Press the Tune +/- buttons on the remote control.
- or
- Press the Up/Down buttons on the front panel.

Scanning Preset Stations

To automatically scan your presets:

- 1 Switch to Preset mode.
- 2 Press the Seek button on the remote control to start scanning presets.
 - The GTP-870HD will play each preset station for a few seconds in sequential order.
- 3 Press the Seek button again to stop scanning.

Improving Tuner Reception

To improve tuner reception:

- Press the St/Mono button on the remote control to switch between Stereo and Mono reception. Sometimes a poor quality stereo signal will improve when switched to Mono mode.

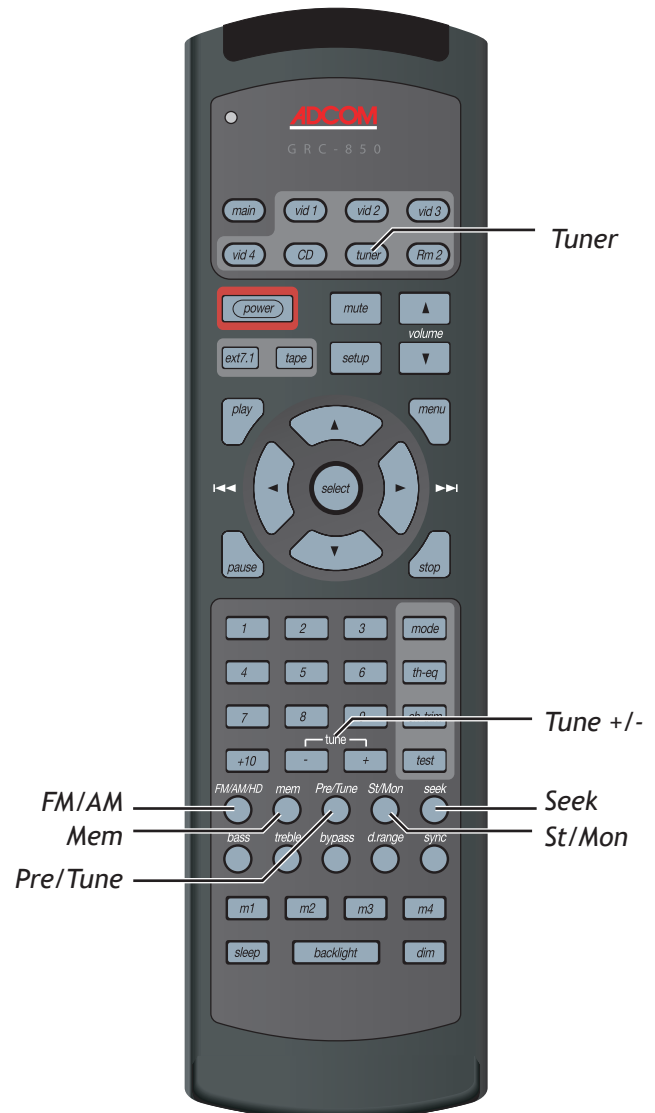

System Operations

The GTP-870HD includes additional features that enhance the user experience, including a built-in sleep timer and front panel display dimmer.

Using the Sleep Timer

If you enjoy falling asleep while watching TV or listening to music, you can use the sleep timer to automatically power off the GTP-870HD after a set period of time.

To set the sleep timer:

- 1 Press the Sleep button on the remote control.
 - The first press displays the current status of the Sleep timer.
 - Subsequent presses change the duration of the sleep timer from 30-180 minutes.
- 2 When the set time elapses, the GTP-870HD will go into Standby mode.

Note:

- To cancel the sleep timer, press the Sleep button until "Sleep Timer Off" appears.

Using the Front Panel Display Dimmer

The front panel display has three brightness levels to suit any need.

To adjust the dimmer:

- 1 Press the Dim button on the remote control.
 - Each press changes the brightness of the front panel display.
 - Choose from bright, medium, or low.

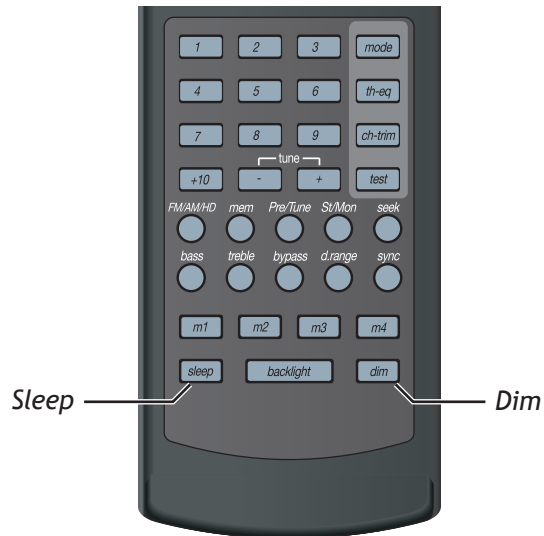

Room 2 Operations

The Room 2 feature makes the GTP-870HD a true multi-tasking device. For example, you can watch a movie in one room and play a CD in another at the touch of a button.

To use the Room 2 feature, you must have:

- An amplifier or receiver connected to the Zone 2 Outputs; see page 28.
- A Room 2 input source specified in the Setup menu; see page 41.

Activating the Room 2 Output

To activate the Room 2 output:

- 1 Power on the GTP-870HD.
- 2 Select the Room 2 output.
 - Press the Rm 2 button on the remote control. or
 - Press the Room 2 On/Off button on the front panel.
- 3 Power on your Room 2 component.
 - Note: The Room 2 component will power on automatically if you connected it to the Zone 2 12V DC trigger.
- 4 Adjust the volume.
 - If you used the Variable Zone 2 outputs, use the Volume knob on the GTP-870HD.
 - If you used the Fixed Zone 2 outputs, use the volume control on your Room 2 component.

Notes:

- *The GTP-870HD can be in Standby or On modes for Room Two operation.*

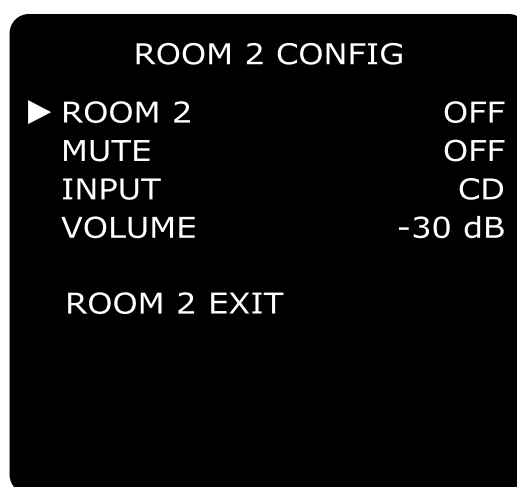

Overriding Default Room 2 Settings

You can change the Room 2 input, volume, and mute settings from the front panel without going through the main Setup menu:

- 1 Select the Room 2 Config menu.
 - Press the Room 2 Setup button on the front panel.
- 2 Make changes to Room 2 settings.
 - Press the Room 2 Setup button repeatedly to step through each menu item.
 - Use the front panel Volume Knob or Up/Down buttons to select menu options.
- 3 Menu options include:
 - Room 2 (On/Off)
 - Mute (On/Off)
 - Input (Video 2-4, CD, Tuner AM/FM)
 - Volume level (-65 dB to 0 dB)

Chapter 5 - Help

Customer Support

Use the Troubleshooting chart on page 64 to resolve common situations that don't require professional attention. If the information provided does not resolve your problem, please contact your Adcom dealer or contact the Adcom customer service department as follows:

Adcom, LLC
8541 E. Anderson Dr., Suite 101
Scottsdale, Arizona 85255

- Telephone: (480) 607-2277
- Fax: (480) 348-9876
- Email: service@adcom.com
- Web: www.adcom.com

Adcom Protection Plan

Adcom offers the enclosed valuable Limited Warranty. Please read the details on the Warranty Card carefully to understand the extent of the protection offered by the Warranty, its reasonable limitations, and what you should do in order to obtain its benefits. Be sure to verify that the serial number printed on the rear panel matches the serial number on the outer carton. If any number is altered or missing, you should notify us immediately in order to ensure that you have received a genuine Adcom product which has not been opened, mishandled, or tampered with in any way. Always retain your original sales receipt as a proof of purchase.

Product Care & Maintenance

Before your Adcom preamp/processor left our factory, it was carefully inspected for physical imperfections and tested for all electrical parameters as a routine part of Adcom's systematic quality control. This, along with full operational and mechanical testing, should ensure a product flawless in both appearance and performance.

After you have unpacked the GTP-870HD, inspect it for physical damage. Save the shipping carton and all packing material as they are intended to reduce the possibility of transportation damage should the unit ever need to be shipped again. In the unlikely event damage has occurred, notify your dealer immediately and request the name of the carrier so a written claim to cover shipping damages can be initiated. The right to a claim against a public carrier can be forfeited if the carrier is not notified promptly in

writing and if the shipping carton and packing materials are not available for inspection by the carrier. Save all packing materials until the claim has been settled.

A Special Note on "Hum"

If there is a low-volume "hum" audible throughout your speakers, even with the main volume turned all the way down, you have a common phenomenon known as a "ground loop." Generally, the cause of a ground loop is the CableTV incoming signal line.

To determine if your cable system is the contributing factor, disconnect the CableTV incoming signal line (round, 75Ω) at the wall, or the first component the cable is connected to (e.g. the cable box or VCR). If the hum is no longer present, you must insert a "75Ω ground loop isolator" before reconnecting the line. Check with your Adcom dealer to obtain one.

System Reset

In rare cases the GTP-870HD internal processor may freeze or lock-up causing abnormal operation. This is common to all micro-processor controlled devices when the unit is subject to excessive static discharge, AC line noise, or power spikes. In most cases it is easy to solve this problem by simply turning off the GTP-870HD with the rear power switch (position 0) for about five minutes. After waiting, turn the unit back on (position 1). If the unit functions normally, no further action is needed.

In the event that the unit still does not operate properly, it may be necessary to manually reset the processor. Note, however, that when the processor is reset you will lose all settings including digital audio assignments, surround mode settings, speaker configurations, tuner presets and any other memory items. For this reason we strongly recommend that you record these settings so that it is easy to restore them after resetting the processor. To reset the unit to factory default settings you will need to enter the discrete remote control command. Please refer back to the discrete remote control commands table. The command name is "Factory Defaults", the IR code is 86h. This should reset the system.

If the manual reset does not solve the problem, contact your authorized Adcom dealer, an authorized Adcom service center or contact Adcom's service department directly for further advice.

Troubleshooting

The table below shows possible causes and solutions to common GTP-870HD issues. If you do not see the answers you need here, please contact your Adcom dealer or customer service department; see page 63.

Symptom	Possible Reason	Possible Solution
No sound	<ul style="list-style-type: none"> Power cable unplugged Rear panel power switch turned off (0) Tape Monitor selected Mute on Incorrect Input Config setting Amplifier powered off 	<ul style="list-style-type: none"> Plug in power cable Turn rear panel power switch on (1) Press Tape to de-select Tape Monitor Switch off Mute Make sure audio input is set correctly in Input Config menu Power on amplifier
No sound on one channel	<ul style="list-style-type: none"> Speaker not properly connected or damaged Input cable disconnected or damaged Speaker set to "None" in menu system 	<ul style="list-style-type: none"> Check connections and speakers Check cables and connections In Speaker Config menu, set speaker to "Small" or "Large"
No sound on surround channels	<ul style="list-style-type: none"> No surround mode selected Mono sound source Speakers/amplifier not properly connected Surround volume level too low 	<ul style="list-style-type: none"> Select a surround mode Test system with stereo or Dolby Surround material Check speaker/amplifier connections Increase surround volume level
No sound on center channel	<ul style="list-style-type: none"> Center speaker set to "None" in menu system Speakers/amplifier not connected properly Center volume level set too low 	<ul style="list-style-type: none"> In Speaker Config menu, set Center speaker to "Small" or "Large" Check speaker/amplifier connections Increase Center volume level
"Dolby Digital" OR "DTS" auto-detection function does not work	<ul style="list-style-type: none"> Source not connected using digital input Incoming signal is set to PCM instead of Bitstream 	<ul style="list-style-type: none"> Connect digital output of source to GTP-870HD Check the Digital Out setting on your source component
Weak bass/diffuse stereo image	<ul style="list-style-type: none"> Speakers wired out of phase 	<ul style="list-style-type: none"> Check connections to all speakers in the system
Remote control not working	<ul style="list-style-type: none"> Batteries dead, or incorrectly inserted IR transmitter or receiver windows obstructed IR receiver in direct sun or bright ambient light 	<ul style="list-style-type: none"> Check or replace batteries Remove obstruction Place unit away from direct sun, reduce amount of ambient light
No sound with tuner	<ul style="list-style-type: none"> Antenna leads incorrectly connected Station not selected or weak signal Mute on 	<ul style="list-style-type: none"> Check antenna connections to preamplifier Re-tune Switch off Mute
Noise, hiss on AM and FM	<ul style="list-style-type: none"> Weak signal 	<ul style="list-style-type: none"> Check station tuning Adjust or replace antenna Press St/Mono button to reduce hiss
Distortion on FM	<ul style="list-style-type: none"> Multi-path signals or interference from another station 	<ul style="list-style-type: none"> Check station tuning Adjust or replace antenna
Whistles or buzzes on FM & AM	<ul style="list-style-type: none"> Interference from other electrical sources, e.g., computers or games consoles 	<ul style="list-style-type: none"> Check station tuning Switch off or move the source of the electrical noise
Whistles or buzzes on AM	<ul style="list-style-type: none"> Interference from fluorescent lighting or electrical motor 	<ul style="list-style-type: none"> Check station tuning Adjust or replace AM antenna
No picture	<ul style="list-style-type: none"> Incorrect TV input selected 	<ul style="list-style-type: none"> Check the input setting on your TV If the GTP-870HD is connected to your TV in more than one way (e.g., S-video and Component video), select the TV input that corresponds with your selected source component
Cannot access setup menu	<ul style="list-style-type: none"> Not in Main mode HDMI or Progressive Scan video output selected 	<ul style="list-style-type: none"> Press Main, then press Setup Select Video, S-video, or Component output to view Setup menus
Cannot power off unit	<ul style="list-style-type: none"> Setup menu is active 	<ul style="list-style-type: none"> Press Setup to exit the Setup menu, then power off unit

Technical Specifications

PREAMPLIFIER ANALOG SECTION

Input Impedance	47k
Output Impedance (Main-RCA).....	<600 Ohm
Rated Input	1.0Vrms
Maximum Input (@ 4Vrms Input Sens.)	4.1Vrms
Rated Output (100k load).....	2.0Vrms
Minimum Load	5k
Maximum Output	8Vrms
Volume & Trim Range (relative to 0dB Trim)	
• Main	-80dB to +18dB (0.5dB res)
• Main Trim	-10dB to +10dB (1.0dB res)
• Main Input Sens./Input	1V/2V/4V
• Room 2	-65dB to +0dB (1.0dB res)
• Room 2 Trim	-8dB to +8dB (1.0dB res)
• Room 2 Gain/Input... ..	+0dB to +6dB (2.0dB res)
Channel Separation (at 1kHz)	(>65dB)
Frequency Response	
• Analog DSP Input	20Hz to 20kHz +0/-0.2dB
• Analog Ext7.1 Input ..	20Hz to 100kHz +0/-0.2dB
THD+N (@ Rated Input & Output)	
• Analog DSP Input	0.007% (20kHz Low Pass)
• Analog Ext7.1 Input ...	0.006% (80kHz Low Pass)
S/N Ratio (ref. 2.0Vrms A-weighted)	
• Analog - DSP Input	93dB
• Analog - Ext 7.1 Input.....	100dB

PREAMPLIFIER DIGITAL SECTION

Frequency Response	
• Digital Input	10Hz to 22kHz +0/-0.2dB
THD+N (@ Rated Input & Output)	
• Digital Input	0.009% (A-weighted)
S/N Ratio (ref. 2.0Vrms A-weighted)	
• Digital Input	99dB
Bass Management (Front/Center/Surround/Sub)	
• High-Pass Slope	Crossover Frequency
• (Small Spkr Setting)....	12dB/octave (2 nd order)
	(Adj. 40/60/80/100/120/150Hz)
• Low-Pass Slope (Sub) ...	24dB/octave (4 th order)
	(Adj. 40/60/80/100/120/150Hz)
• Delay Mgmt (Feet or Meters relative 1ms/ft)	
• Front/Center/Surr/Surr Back/Sub	0-20 ft
• Lip Sync Delay	0-169mS

FM TUNER SECTION

Sensitivity	
• 30dB S/N.....	6dBu typ.
S/N Ratio	
• Mono	65dB typ.
• Stereo	55dB typ.
Distortion	
• Mono	0.3% typ.
• Stereo	0.5% typ.
Stereo Separation.....	35dB typ.
Adjacent Channel Selectivity	50dB typ.
Frequency Response.....	50Hz to 15kHz +/-3dB

VIDEO SECTION

Impedance (Input/Output)	75 Ohm
Bandwidth	
• Composite & S-Video	6MHz -3dB
• Component.....	200MHz -3dB
Transcoding	
• Composite/S-Video/Component	480i & 576i
Switching	
• HD Component (Auto Bypass)	480p-1080p
• HDMI (Switching Video/Audio/ DDC/HPD)	480i-1080p

GENERAL

Supply Voltage (Switchable).....	120vAC-60Hz/ 230vAC-50Hz
Power Consumption	50watt maximum
Dimensions	
• Width.....	17 inches (431.8mm)
• Rack Height	7 inches (177.8mm)
• Full Height.....	7.5 inches (190.5mm)
• Depth of Chassis.....	15.5 inches (393.7mm)
• Full Depth	19 inches (482.6mm)
Unit Weight	35 lbs. (15.9kg)
Trigger Outputs	
• Main	50mA @ 12vDC
• Room 2.....	50mA @ 12vDC
IR Inputs	
• Main	3.5mm T/R
• Room 2.....	3.5mm T/R
RS232 Control.....	9600 baud/8 - N-1/ Flow Control = Hardware

Specifications are subject to change without notice.

A

Analog Input Level 45
Audio Cables 13

C

Channel Balance 39
Connections
 Amplifier 24, 25
 Antenna 14
 Audio/Video 15
 CableTV box 15
 CD Player 21
 Component Video 17
 Digital Audio 18
 DVD Player 16
 External Decoder 20
 HDMI 19
 HDTV set-top box 15
 iPod docking station 15
 IR Sensor 29
 Laser disc player 15
 Media PC 15
 Overview 13
 Power Cable 30
 Progressive Scan 17
 PVR 15
 Recorder 26
 Room 2 28
 Satellite receiver 15
 Subwoofer 25
 Tape Player 21
 Trigger 29
 TV 22
 VCR 15
Customer Support 63

D

Delay Configuration 38
Dimmer 61

F

Features 5
Front Panel
 Display 12
 Overview 7

H

HDMI 19, 22, 34

I

Input Configuration 33
Input Labeling 44

L

Label Source 44
Lip Sync Delay 9

M

Macro Programming 52

N

Neo:6 Configuration 40

O

On-Screen Display 12, 22

P

Picture Controls 35
Picture Format 56
Placement 6
Playback
 Basic Audio/Video 56
 External 7.1 56
 Tape 56
Preprogrammed Commands 47,
 48, 49
Product Care & Maintenance 63
Pro Logic IIx Configuration 40

R

Rear Panel
 Overview 10
Recording 59
Regulatory Information 4
Remote Control
 Batteries 6
 Discrete Commands 53
 Overview 8
 Programming 50
 Setup 46
Room 2 Configuration
 Advanced 42
 Basic 41
Room 2 Operations 62

S

Safety Instructions 4
Scaler 19, 34
Setup
 Navigation 32
 Overview 31
Sleep Timer 61
Speaker
 Configuration 37
 Placement 23
Surround Modes
 Dolby 57
 DTS 57
 Selecting 57
Sync 9, 56
System Configuration 43
System Operations 61

T

Tone Control 58
Troubleshooting 64
Tuner Operations 60

U

Unpacking 5

V

Video Cables 13
Voltage Switch 30
Volume/Tone Configuration 36

W

Warranty 63

Adcom shall not be liable for any errors contained herein or for any damages arising out of or related to this document or the information contained herein, even if Adcom has been advised of the possibility of such damages. This document is intended for informational and instructional purposes only. Adcom reserves the right to make changes in the specifications and other information contained in this document without prior notification. Adcom disclaims any obligation to update the information contained herein.



8541 East Anderson Drive, Suite 101
Scottsdale, Arizona 85255
Voice: 480.607.2277
Fax: 480.348.9876
www.adcom.com